



IP Office

H323 Telephone Installation

Notices

While reasonable efforts have been made to ensure that the information in this document is complete and accurate at the time of printing, Avaya assumes no liability for any errors. Avaya reserves the right to make changes and corrections to the information in this document without the obligation to notify any person or organization of such changes.

Documentation disclaimer

Avaya shall not be responsible for any modifications, additions, or deletions to the original published version of this documentation unless such modifications, additions, or deletions were performed by Avaya.

End User agree to indemnify and hold harmless Avaya, Avaya's agents, servants and employees against all claims, lawsuits, demands and judgments arising out of, or in connection with, subsequent modifications, additions or deletions to this documentation, to the extent made by End User.

Link disclaimer

Avaya is not responsible for the contents or reliability of any linked Web sites referenced within this site or documentation(s) provided by Avaya. Avaya is not responsible for the accuracy of any information, statement or content provided on these sites and does not necessarily endorse the products, services, or information described or offered within them. Avaya does not guarantee that these links will work all the time and has no control over the availability of the linked pages.

Warranty

Avaya provides a limited warranty on this product. Refer to your sales agreement to establish the terms of the limited warranty. In addition, Avaya's standard warranty language, as well as information regarding support for this product, while under warranty, is available to Avaya customers and other parties through the Avaya Support Web site: <http://www.avaya.com/support>. Please note that if you acquired the product from an authorized Avaya reseller outside of the United States and Canada, the warranty is provided to you by said Avaya reseller and not by Avaya.

Licenses

THE SOFTWARE LICENSE TERMS AVAILABLE ON THE AVAYA WEBSITE, [HTTP://SUPPORT.AVAYA.COM/LICENSEINFO/](http://support.avaya.com/licenseinfo/) ARE APPLICABLE TO ANYONE WHO DOWNLOADS, USES AND/OR INSTALLS AVAYA SOFTWARE, PURCHASED FROM AVAYA INC., ANY AVAYA AFFILIATE, OR AN AUTHORIZED AVAYA RESELLER (AS APPLICABLE) UNDER A COMMERCIAL AGREEMENT WITH AVAYA OR AN AUTHORIZED AVAYA RESELLER. UNLESS OTHERWISE AGREED TO BY AVAYA IN WRITING, AVAYA DOES NOT EXTEND THIS LICENSE IF THE SOFTWARE WAS OBTAINED FROM ANYONE OTHER THAN AVAYA, AN AVAYA AFFILIATE OR AN AVAYA AUTHORIZED RESELLER, AND AVAYA RESERVES THE RIGHT TO TAKE LEGAL ACTION AGAINST YOU AND ANYONE ELSE USING OR SELLING THE SOFTWARE WITHOUT A LICENSE. BY INSTALLING, DOWNLOADING OR USING THE SOFTWARE, OR AUTHORIZING OTHERS TO DO SO, YOU, ON BEHALF OF YOURSELF AND THE ENTITY FOR WHOM YOU ARE INSTALLING, DOWNLOADING OR USING THE SOFTWARE (HEREINAFTER REFERRED TO INTERCHANGEABLY AS "YOU" AND "END USER"), AGREE TO THESE TERMS AND CONDITIONS AND CREATE A BINDING CONTRACT BETWEEN YOU AND AVAYA INC. OR THE APPLICABLE AVAYA AFFILIATE ("AVAYA").

Avaya grants End User a license within the scope of the license types described below. The applicable number of licenses and units of capacity for which the license is granted will be one (1), unless a different number of licenses or units of capacity is specified in the Documentation or other materials available to End User. "Designated Processor" means a single stand-alone computing device. "Server" means a Designated Processor that hosts a software application to be accessed by multiple users. "Software" means the computer programs in object code, originally licensed by Avaya and ultimately utilized by End User, whether as stand-alone products or pre-installed on Hardware. "Hardware" means the standard hardware originally sold by Avaya and ultimately utilized by End User.

License types

Designated System(s) License (DS). End User may install and use each copy of the Software on only one Designated Processor, unless a different number of Designated Processors is indicated in the Documentation or other materials available to End User. Avaya may require the Designated Processor(s) to be identified by type, serial number, feature key, location or other specific designation, or to be provided by End User to Avaya through electronic means established by Avaya specifically for this purpose.

Copyright

Except where expressly stated otherwise, no use should be made of materials on this site, the Documentation(s) and Product(s) provided by Avaya. All content on this site, the documentation(s) and the product(s) provided by Avaya including the selection, arrangement and design of the content is owned either by Avaya or its licensors and is protected by copyright and other intellectual property laws including the sui generis rights relating to the protection of databases. You may not modify, copy, reproduce, republish, upload, post, transmit or distribute in any way any content, in whole or in part, including any code and software. Unauthorized reproduction, transmission, dissemination, storage, and or use without the express written consent of Avaya can be a criminal, as well as a civil, offense under the applicable law.

Third Party Components

Certain software programs or portions thereof included in the Product may contain software distributed under third party agreements ("Third Party Components"), which may contain terms that expand or limit rights to use certain portions of the Product ("Third Party Terms"). Information regarding distributed Linux OS source code (for those Products that have distributed the Linux OS source code), and identifying the copyright holders of the Third Party Components and the Third Party Terms that apply to them is available on the Avaya Support Web site: <http://support.avaya.com/Copyright>.

Preventing toll fraud

"Toll fraud" is the unauthorized use of your telecommunications system by an unauthorized party (for example, a person who is not a corporate employee, agent, subcontractor, or is not working on your company's behalf). Be aware that there can be a risk of toll fraud associated with your system and that, if toll fraud occurs, it can result in substantial additional charges for your telecommunications services.

Avaya fraud intervention

If you suspect that you are being victimized by toll fraud and you need technical assistance or support, call Technical Service Center Toll Fraud Intervention Hotline at +1-800-643-2353 for the United States and Canada. For additional support telephone numbers, see the Avaya Support Web site: <http://support.avaya.com>. Suspected security vulnerabilities with Avaya products should be reported to Avaya by sending mail to: securityalerts@avaya.com.

Trademarks

Avaya and Aura are trademarks of Avaya, Inc. The trademarks, logos and service marks ("Marks") displayed in this site, the documentation(s) and product(s) provided by Avaya are the registered or unregistered Marks of Avaya, its affiliates, or other third parties. Users are not permitted to use such Marks without prior written consent from Avaya or such third party which may own the Mark. Nothing contained in this site, the documentation(s) and product(s) should be construed as granting, by implication, estoppel, or otherwise, any license or right in and to the Marks without the express written permission of Avaya or the applicable third party. Avaya is a registered trademark of Avaya Inc. All non-Avaya trademarks are the property of their respective owners.

Downloading documents

For the most current versions of documentation, see the Avaya Support Web site: <http://www.avaya.com/support>

Contact Avaya Support

Avaya provides a telephone number for you to use to report problems or to ask questions about your product. The support telephone number is 1-800-242-2121 in the United States. For additional support telephone numbers, see the Avaya Web site: <http://www.avaya.com/support>

Contents

1. IP Office H323 IP Phones

- 1.1 Supported Phones..... 8
- 1.2 System Capacity..... 9
- 1.3 Phone Firmware..... 10
- 1.4 Simple Installation..... 11
- 1.5 Installation Requirements..... 12
- 1.6 Licenses 13
- 1.7 Network Assessment..... 14
- 1.8 Voice Compression Channels..... 15
- 1.9 QoS 17
- 1.10 Potential VoIP Problems..... 17
- 1.11 User PC Connection..... 18
- 1.12 Power Supply Options..... 19
- 1.13 File Server Options..... 21
- 1.14 File Auto-Generation..... 22
- 1.15 Control Unit Memory Card..... 22

2. Installation

- 2.1 Licensing 25
 - 2.1.1 Checking the Serial Number..... 25
 - 2.1.2 Adding Licenses..... 26
 - 2.1.3 Reserving Licenses..... 26
- 2.2 System H323 Support..... 27
 - 2.2.1 Enabling the H323 Gatekeeper..... 27
 - 2.2.2 Setting the RTP Port Range..... 28
 - 2.2.3 Configuring SRTP..... 29
 - 2.2.4 Enabling RTCP Quality Monitoring..... 30
 - 2.2.5 Adjusting DiffServ QoS..... 32
- 2.3 DHCP Settings..... 33
 - 2.3.1 System DHCP Support..... 35
 - 2.3.2 System Site Specific Option Numbers..... 36
- 2.4 File Server Settings..... 37
 - 2.4.1 System File Server Settings..... 38
 - 2.4.2 Creating/Editing the Settings File..... 39
 - 2.4.3 Loading Software Files onto the System..... 41
 - 2.4.4 Loading Files onto a 3rd Party Server..... 44
- 2.5 User and Extension Creation..... 45
 - 2.5.1 Auto-Creation..... 45
 - 2.5.2 Manually Creating User..... 46
 - 2.5.3 Manually Creating Extensions..... 46
- 2.6 Phone Connection..... 48
- 2.7 Static Address Installation..... 49
- 2.8 Phone Registration..... 51
- 2.9 Backup/Restore Settings..... 52
 - 2.9.1 Example File..... 53
 - 2.9.2 IIS Server Configuration..... 54
 - 2.9.3 Apache Server Configuration..... 54
- 2.10 Listing Registered Phones..... 55
- 2.11 Other Installation Options..... 55
 - 2.11.1 VPN Remote Phones..... 55
 - 2.11.2 VLAN and IP Phones..... 59

3. Static Administration Options

- 3.1 Secondary Ethernet (Hub)/IR Interface Enable/Disable..... 67

- 3.2 View Details..... 68
- 3.3 Self-Test Procedure..... 70
- 3.4 Resetting a Phone..... 71
- 3.5 Clearing a Phone..... 72
- 3.6 Site Specific Option Number..... 73

4. Restart Scenarios

- 4.1 Boot File Needs Upgrading..... 77
- 4.2 No Application File or Application File Needs Upgrading 77
- 4.3 Correct Boot File and Application File Already Loaded 77

5. Infrared Dialing

- 5.1 Enabling the IR Port..... 81
- 5.2 Dialing Phone Numbers..... 81
- 5.3 Beaming Files During a Call..... 82

6. Alternate DHCP Server Setup

- 6.1 Alternate Options..... 85
- 6.2 Checking for DHCP Server Support..... 86
- 6.3 Creating a Scope..... 86
- 6.4 Adding a 242 Option..... 86
- 6.5 Adding a 176 Option..... 87
- 6.6 Activating the Scope..... 89

7. WML Server Setup

- 7.1 Testing 4620 WML Browsing Using Xitami..... 93
- 7.2 Setting the Home Page..... 95
- 7.3 Apache Web Server WML Configuration..... 96
- 7.4 Microsoft IIS Web Server WML Configuration..... 96
- 7.5 Open URL Entry..... 97
- Index99

Chapter 1.

IP Office H323 IP Phones

1. IP Office H323 IP Phones

This documentation provides notes for the installation of [supported Avaya IP phones](#)^[8] onto an IP Office system. It should be used in conjunction with the existing installation documentation for those series of phones, especially the following:

- [9600 Series IP Telephones Administrator Guide](#) (16-300698)
- [4600 Series IP Telephone LAN Administrator Guide](#) (555-233-507)
- [1600 Series IP Telephones Administrators Guide](#) (16-601443).

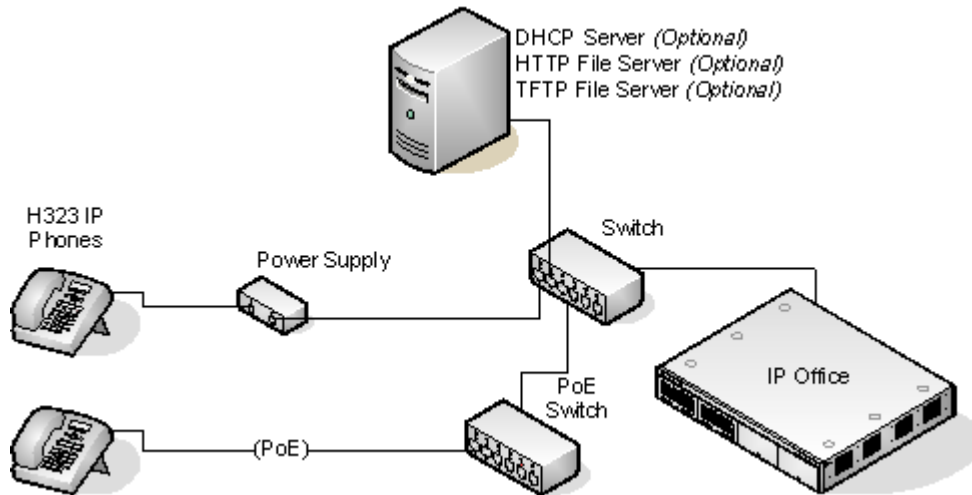

- **DHCP versus Static IP Installation**

Though static IP installation of H323 IP phones is possible, installation using DHCP is strongly recommended. The use of DHCP eases both the installation process and future maintenance and administration. For static installations, following a boot file upgrade, all static address settings are lost and must be re-entered.

- **Network Assessment**

High quality voice transmission across an IP network requires careful assessment of many factors. Therefore:

- We strongly recommend that IP phone installation is only done by installers with VoIP experience.
- The whole customer network must be assessed for its suitability for VoIP, before installation. Avaya may refuse to support any installation where the results of a network assessment cannot be supplied. See [Network Assessment](#)^[14] for further details.

1.1 Supported Phones

This documentation provides installation notes for the following Avaya IP phones supported by IP Office. Other supported Avaya H323 IP phones, for example DECT R4 3700 Series phones are covered by separate installation documentation.

H323 IP Phones	Supported Models	802.3af PoE Class		PC Port	IP Office Core Software
		Class	Idle		
1600 Series	1603	2	4.4W	-	4.2 Q4 2008 +.
	1603SW	2	4.4W	✓	
	1608	2	3.7W	✓	
	1616	2	2.7W	✓	
4600 Series	4601	2	3.5W	-	3.0+
	4602	1	-	-	2.1+.
	4602SW	2	3.5W	✓	
	4606	0	4.1W	✓	Up to 3.2.
	4610SW ^[1]	2	4.0W	✓	3.0+.
	4612	0	4.1W	✓	Up to 3.2.
	4620	3	4.0W	-	2.0+.
	4620SW	2	-	✓	
	4621SW ^[1]	2	5.75W	✓	3.0+.
	4624	0	4.1W	✓	Up to 3.2.
	4625	3	6.45W	✓	3.2+
5600 Series	5601	2	3.5W	-	3.0+.
	5602	1	-	-	
	5602SW	2	4.1W	✓	
	5610SW ^[1]	2	3.1W	✓	
	5620	3	3.6W	✓	
	5621SW ^[1]	2	-	✓	3.2+.
9600 Series	9620L	1	2.0W	✓	6.0+
	9620C	2	3.9W	✓	
	9630G	2	4.6W	✓	
	9640	2	3.9W	✓	
	9640G	2	3.9W	✓	
	9650	2	4.7W	✓	
	9650C	2	3.7W	✓	
	9608	1	2.08W	✓	8.0+
	9611G	1	2.8W	✓	
	9621G	2	3.49W	✓	
	9641G	2	3.44W	✓	

1. VPNremote Support

These phones can also be used with VPNremote firmware.

2. 1603/1603SW

These phones require a PoE Splitter unit in order to use PoE.

1.2 System Capacity

System capacity encompasses the number of configurable phone extensions and the number of simultaneous IP phone calls.

Extension Capacity

The maximum number of H323 IP phones supported by an IP Office system is based on that system's maximum capacity for extensions of any type as listed in the table below. To find the capacity for IP phones subtract the number of physical non-IP extensions installed on the system, ie. extension ports on the IP Office control unit and any external expansion modules.

IP Office Unit	Maximum Extensions	Maximum VCM Channels
IP500	384	128
IP500 V2	384	148

Call Capacity

There are a number of situations where the IP Office system needs to provide a voice compression channel in order for an IP phone to make calls. These channels are provided by Voice Compression Modules (VCMs) installed in the IP Office system. The number of VCM channels required and how long the channel is required will depend on a number of factors. For further details see [Voice Compression](#) ¹⁵.

A simple summary is:

- A VCM channel is required during call setup.
- The VCM channel is released if the call is to/from another IP device using the same compression codec (the supported VCM codecs are G.711, G.729 and G.722).
- The VCM channel is used for the duration of the call when the call is to/from/via a non-IP device (extension or trunk line).
- It should be remembered that VCM channels are also used for calls from non-IP devices to IP lines if those are configured in the IP Office system (IP, SIP and SES lines).
- Calls from IP phones to the IP Office voicemail server use a VCM channel.
 - Note that on Small Office Edition systems with Embedded Voicemail, an additional channel is used for every call to voicemail.

1.3 Phone Firmware

The firmware used by Avaya IP phones is upgradeable and different releases of firmware are made available via the Avaya support website. However, H323 IP phones used on a IP Office system must only use the firmware supplied pre-installed with the IP Office system or with its IP Office Manager application. Other versions of IP Phone firmware may not have been tested specifically with IP Office systems and so should not be used unless IP Office support is specifically mentioned in the firmware's accompanying documentation.

The firmware consists of a number of different types of files:

- **xxupgrade Files**

The first file that a phone requests when starting up is the **xxupgrade** file. This file contains a list of the phone .bin files that are available as part of the firmware set and the version numbers of those files. If the version of a file differs from that which the phone already has loaded, the phone will request the new file. During this process the phone may reboot after loading each file and then request the xxupgrade.txt file again until it has updated all its firmware, if necessary. Separate files are provided for the different phone series:

- **16xxupgrade.txt**

- This file lists the firmware files that 1600 Series phones should load.

- **46xxupgrade.scr**

- This file lists the firmware files that 4600 Series and 5600 Series phones should load.

- **96xxupgrade.txt**

- This file lists the firmware files that 9600 Series phones should load.

- **96x1Hupgrade.txt**

- This file list the firmware files that 9608, 9611, 9621, and 9641 phones should load.

- **.bin Files**

Following the instructions in the xxupgrade.txt file, the phone will load any .bin files it requires if their versions differ from that which the phone already has loaded.

- **.tar Files**

Instead of the .bin file used by other phones, the 9600 Series phones use .tar archive files to download multiple files in a single step and then unpack the .tar files to load their contents.

- **46xxsettings.txt File**

The last line of the xxupgrade.txt file instructs the phone to load a **46xxsettings.txt** file. This is an [editable file](#) ³⁹ which can be used to adjust the operation of the phones.

- **.lng Files**

The firmware may include language files for use by 1600 Series and 9600 Series phones. Which of these language files are loaded is set in the **46xxsettings.txt** file.

File Auto-Generation

When the IP Office system is acting as the file server for the phones, it is able to auto-generate the **46xxsettings.txt** and .lng files used by the phones. It will do this if the requested file is not physically present in the location where the system is storing the firmware files.

Firmware Source Sets

The phone firmware files are installed as part of the IP Office Manager application and are found in the application's installation directory. By default, the directory is found at **c:\Program Files\Avaya\IP Office\Manager**.

The same firmware files can also be obtained directly from the software package used to install IP Office Manager without having to perform the installation. The files are located in the **\program files\Avaya\IP Office\Manager** sub-folder of the installation directory.

Note that these sets of files include .bin files that are also used for other devices including the IP Office system itself.

1.4 Simple Installation

The diagram below shows the simplest installation scenario. This has the IP Office system acting as the DHCP and file servers for all the IP phones registered with it.

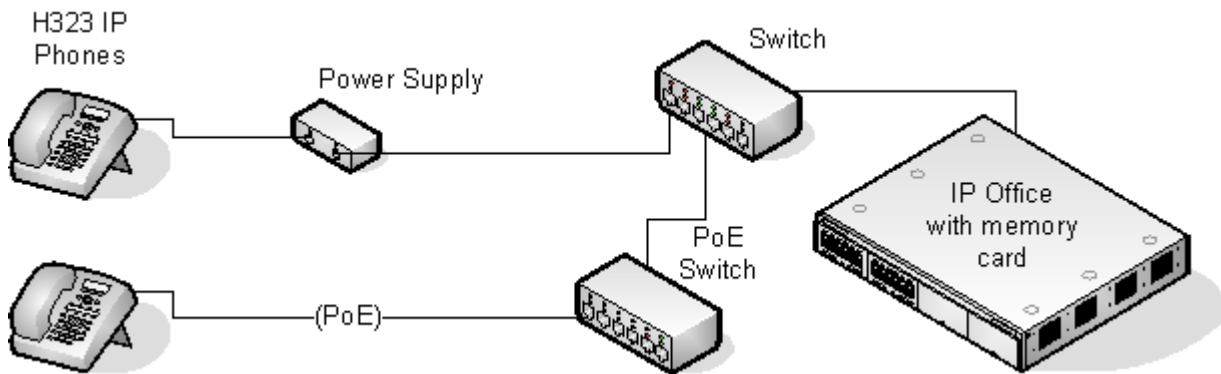

This type of installation uses the following equipment:

- **IP Office Server**

The IP Office system performs a number of roles for the phones:

- **DHCP Server**

The IP Office system is acting as the DHCP server for the phones. The DHCP response to the phones includes both IP address settings, details of the file server to use as configured in the IP Office configuration and the systems on address as the H323 gatekeeper for the phones. The IP Office DHCP function can be configured to provide DHCP addresses only in response to requests from Avaya IP phones. This allows an alternate DHCP server to be used for other devices that use DHCP.

- **H323 Gatekeeper**

IP phones require an H323 gatekeeper to which they register. The gatekeeper then controls the connection of calls to and from the phone. In this and all scenarios the IP Office systems as the H323 Gatekeeper.

- **File Server**

During installation the IP phones need to download [firmware files](#)^[10] for a file server. This is done using either HTTPS, HTTP or TFTP in that order (1600 and 9600 Series phones do not support TFTP). If the IP Office control unit is fitted with a memory card (mandatory on IP500 v2 control units), that card can be used as the file source.

- The IP Office system can use its own memory card to act as the file server for up to 50 phones. For larger numbers a separate 3rd-party HTTP server should be used.
- The IP Office system is currently not supported as a file server for 9608, 9611, 9621, and 9641 phones. This also applies to using the IP Office Manager application acting as the file server. These phones are only supported when using a 3rd-party file server.

- **Backup/Restore Server**^[52]

1600 Series and 9600 Series phones can be configured to backup and restore user and phone settings to a server. The address of this server is set separately from that of the file server used for phone firmware though the same server may be useable. The recommended method is to use the IP Office system as the server for this function.

- **Switches**

The IP Office has a limited number of LAN connection ports, intended only to connect itself to the existing data network. The addition of IP phones will require the network to include additional port capacity.

- **Power Supplies**^[19]

Each H323 IP phone requires a power supply. The IP Office system does not provide any power to IP phones. The phones can be

- **Power over Ethernet Supply**

Most Avaya IP phones can be powered from an 802.3af Power over Ethernet (PoE) power supply. This can be done using PoE switches to support multiple phones or using individual PoE injector devices for each phone.

- **Individual Power Supply Units**

An individual power supply unit can be used with each phone. This will require a power supply socket at each phone location. Note that for phones using a button module add-on, for example a EU24 or BM32, an individual power supply unit is often a requirement. The type of power supply will depend on the type of phone.

1.5 Installation Requirements

To install an IP phone on IP Office, the following items are required:

- **Network Assessment**

A network assessment must be completed. Avaya will not support VoIP on a network where a satisfactory [network assessment](#)^[14] has not been obtained.

- **Extension Number and User Details**

A full listing of the planned extension number and user name details is required. The planned extension number must be unused and is requested by the phone during installation.

- **Power Supplies**

Each phone requires a power supply. Avaya IP phones do not draw power from the IP Office. A number of options exist for how power is supplied to the phones and all the Avaya IP deskphones support Power over Ethernet (PoE). See [Power Supply Options](#)^[19].

- **LAN Socket**

An RJ45 Ethernet LAN connection point is required for each phone.

- **Category 5 Cabling**

All LAN cables and LAN cable infrastructure used with H323 IP phones should use CAT5 cabling.

- **LAN Cables**

Check that an RJ45 LAN cable has been supplied with the IP phone for connection to the power supply unit. You may also need an additional RJ45 LAN cable for connection from the power unit to the customer LAN. This will depend on the type of power supply being used.

- A further RJ45 LAN cable can be used to connect the user's PC to the LAN via the IP phone (not supported on 4601, 4602, 5601 and 5602 H323 IP phones).

- **Voice Compression Channels**

The IP Office Unit must have voice compression channels installed. Channels are required during the connection if calls involving IP phones and may also be required during the call. See [Voice Compression Channels](#)^[15] for full details. For IP500 and IP500 V2 control units, channels are installed using a IP500 VCM base card and licenses or using IP400 VCM modules on an IP500 Legacy Card.

- **DHCP Server**

The IP Office Unit can perform this role for all the phones. If another DHCP server is used for the network, this may be able to do DHCP for the H323 IP phones, see [Alternate DHCP Servers](#)^[84]. Also the IP Office system can be configured to only provide DHCP support to Avaya IP phones.

- [Static IP addressing](#)^[49] can also be used for IP phone installation if required. However that method of installation is not recommended.

- **HTTP File Server**

A PC running the <MANAGER> application can perform this role for up to 5 H323 IP phones. An IP Office control unit with a memory card can use that memory card as the source for up to 50 phones. For larger numbers a separate 3rd-party HTTP server should be used.

- The IP Office system is currently not supported as a file server for 9608, 9611, 9621, and 9641 phones. This also applies to using the IP Office Manager application acting as the file server. These phones are only supported when using a 3rd-party file server.

- **H323 Gatekeeper**

The IP Office system performs this role.

- **IP Office Manager**

A Windows PC running IP Office Manager is required for IP Office configuration changes. The PC should also have System Status Application and IP Office System Monitor installed.

- **IP Telephone Software**

The software for IP phone installation is installed into the IP Office Manager application's program folder as during the applications installation. It is also included as part of the IP Office for Linux applications installation of the IP Office application on the server.

- **Licence Keys**

Each Avaya IP phones registered with the system requires an Avaya **Avaya IP Endpoint** licenses to operate. Refer to [Licenses](#)^[13].

- **Backup/Restore Server**^[52]

The phones backup and restore various phone and user settings whenever the user logs on or logs out. This uses files stored on a file server. This is not necessarily the same server as used for the phone firmware files. The IP Office system's own file storage can be used for this function and is the recommended option.

1.6 Licenses

The following licensing rules apply to the support of Avaya H323 IP phones on a IP Office system. Note that B5800 Branch Gateway uses a different licensing system and different licensing rules. A B5800 Native Station license is required for each H323 phone on B5800. Please refer to the B5800 Branch Gateway Implementation Guide for more information.

- An **Avaya IP Endpoint** license is required for each Avaya H323 IP phones. This includes all 1600, 4600, 5600, 9600, IP DECT, DECT R4, T3 IP and Spectralink.
 - The system will automatically license 12 Avaya IP phones for each IP500 VCM 32 or VCM 64 card installed in the system without requiring additional licenses to be added to the configuration.
 - Additional Avaya IP phones are licensed either by the addition of **Avaya IP Endpoints** licenses above or the conversion of legacy **IP500 VCM Channels** licenses to **Channel Migration** licenses (see below).
 - By default licenses are consumed by each Avaya IP phone that registers with the IP Office in the order that they register. The license is released if the phone unregisters. However, it is possible to reserve a license for particular phones in order to ensure that they phones always obtain a license. This is done through the **Reserve Avaya IP Endpoint Licence** setting of each IP extension.
 - Avaya IP phones without a license will still be able to register but will be limited to making emergency calls only (Dial Emergency short code calls). The associated user will be treated as if logged off and the phone will display *"No license available"*. If a license becomes available, it will be assigned to any unlicensed DECT handsets first and then to any other unlicensed Avaya IP phone in the order that the phones registered.
- For existing IP500 systems being upgraded to IP Office Release 6, the existing VCM channels and IP500 VCM Channels license are treated as follows:
 - For each IP400 VCM card installed in the system, each VCM channel supported by the card allows support for 3 Avaya IP phones.
 - For each IP500 VCM32 and IP500 VCM64 card installed in the system, the 4 unlicensed VCM channels previously provided by each card are converted to allow unlicensed support of 12 Avaya IP phones.
 - For each legacy **IP500 VCM Channels** license, the license are converted **Channel Migration** licenses supporting 3 Avaya IP phones. See the Channel Migration license below.
 - The IP500 VCM 32 and IP500 VCM 64 cards will provide their full capacity of VCM channels, ie. providing up to 32 or 64 channels depending on the card type and the codecs being used.

Licenses are issued against a unique feature key/dongle serial number. For IP500v2 control units that number is unique to the System SD card fitted to the system. For IP500 control units that number is unique to the smart media card inserted in the back of the control unit. To be valid, any licenses entered into the system configuration must be licenses issued against that serial number. B5800 Branch Gateway licenses are issued against a unique PLDS Host ID.

1.7 Network Assessment

The IP Office system is a pure Voice over IP (VoIP) system. All trunks and telephone extensions connect to the system via the customer's data network. It is therefore absolutely imperative that the customer network is assessed and reconfigured if necessary to meet the needs of VoIP traffic.

- **! WARNING: A Network Assessment is Mandatory**

When installing IP phones on a IP Office system, it is assumed by Avaya that a network assessment has been performed. If a support issue is escalated to Avaya, Avaya may request to see the results of a recent network assessment and may refuse to provide support if a network assessment with satisfactory results has not been performed.

Current technology allows optimally configured networks to deliver VoIP services with voice quality that matches that of the public phone network. However, few networks are optimally configured and so care should be taken to assess the VoIP quality achievable within a customer network.

Not every network is able to carry voice transmissions. Some data networks have insufficient capacity for voice traffic or have data peaks that will occasionally impact voice traffic. In addition, the usual history of growing and developing a network by integrating products from many vendors makes it necessary to test all the network components for compatibility with VoIP traffic.

A network assessment should include a determination of the following:

- A network audit to review existing equipment and evaluate its capabilities, including its ability to meet both current and planned voice and data needs.
- A determination of network objectives, including the dominant traffic type, choice of technologies and setting voice quality objectives.
- The assessment should leave you confident that the network will have the capacity for the foreseen data and voice traffic.

Network Assessment Targets

The network assessment targets are:

- **Latency:** *Less than 180ms for good quality. Less than 80ms for toll quality.*
This is the measurement of packet transfer time in one direction. The range 80ms to 180ms is generally acceptable. Note that the different audio codecs used each impose a fixed delay caused by the codec conversion as follows:
 - **G.711:** 20ms.
 - **G.722:** 40ms.
 - **G.729:** 40ms.
- **Packet Loss:** *Less than 3% for good quality. Less than 1% for toll quality.*
Excessive packet loss will be audible as clipped words and may also cause call setup delays.
- **Jitter:** *Less than 20ms.*
Jitter is a measure of the variance in the time for different packets in the same call to reach their destination. Excessive jitter will become audible as echo.
- **Duration:** *Monitor statistics once every minute for a full week.*
The network assessment must include normal hours of business operation.

1.8 Voice Compression Channels

Calls to and from IP devices can require conversion to the audio codec format being used by the IP device. For IP Office systems this conversion is done by voice compression channels. These support the common IP audio codecs G.711, G.722, and G.729a.

For IP400 control units channels can be added by fitting IP400 Voice Compression Modules (VCMs). For the IP500 control units, channels can be added using IP500 VCM cards, IP500 Combination Cards and or IP400 Voice Compression Modules.

The voice compression channels are used as follows:

Call Type	Voice Compression Channel Usage
IP Device to Non-IP Device	These calls require a voice compression channel for the duration of the call. If no channel is available, busy indication is returned to the caller.
IP Device to IP Device	<p>Call progress tones (for example dial tone, secondary dial tone, etc) do not require voice compression channels with the following exceptions:</p> <ul style="list-style-type: none"> • Short code confirmation, ARS camp on and account code entry tones require a voice compression channel. <p>When a call is connected:</p> <ul style="list-style-type: none"> • If the IP devices use the same audio codec no voice compression channel is used. • If the devices use differing audio codecs, a voice compression channel is required for each.
Non-IP Device to Non-IP Device	No voice compression channels are required.
Music on Hold	This is provided from the IP Office's TDM bus and therefore requires a voice compression channel when played to an IP device.
Conference Resources and IP Devices	Conferencing resources are managed by the conference chip which is on the IP Office's TDM bus. Therefore, a voice compression channel is required for each IP device involved in a conference. This includes services that use conference resources such as call listen, intrusion, call recording and silent monitoring.
Page Calls to IP Device	IP Office 4.0 and higher only uses G.729a for page calls, therefore only requiring one channel but also only supporting pages to G.729a capable devices.
Voicemail Services and IP Devices	Calls to the IP Office voicemail servers are treated as data calls from the TDM bus. Therefore calls from an IP device to voicemail require a voice compression channel.
Fax Calls	These are voice calls but with a slightly wider frequency range than spoken voice calls. IP Office only supports fax across IP between IP Office systems with the Fax Transport option selected. It does not currently support T38.
T38 Fax Calls	<p>IP Office 5.0+ supports T38 fax on SIP trunks and SIP extensions. Each T38 fax call uses a VCM channel.</p> <p>Within a Small Community Network, a T38 fax call can be converted to a call across an H323 SCN lines using the IP Office Fax Transport Support protocol. This conversion uses 2 VCM channels.</p> <p>In order use T38 Fax connection, the Equipment Classification of an analog extension connected to a fax machine can be set Fax Machine. Additionally, a new short code feature Dial Fax is available.</p>

Note: T3 IP devices must be configured to 20ms packet size for the above conditions to apply. If left configured for 10ms packet size, a voice compression channel is needed for all tones and for non-direct media calls.

Measuring Channel Usage

The IP Office system Status Application can be used to display voice compression channel usage. Within the **Resources** section it displays the number of channel in use. It also displays how often there have been insufficient channels available and the last time such an event occurred.

The IP500 VCM cards, the level of channel usage is also indicated by the LEDs (1 to 8) on the front of the IP500 VCM card.

Installing VCM Cards

Refer to the IP Office Installation manual.

1.9 QoS

When transporting voice over low speed links it is possible for normal data packets (1500 byte packets) to prevent or delay voice packets (typically 67 or 31 bytes) from getting across the link. This can cause unacceptable speech quality.

Therefore, it is vital that all traffic routers and switches in the network have some form of Quality of Service (QoS) mechanism. QoS routers are essential to ensure low speech latency and to maintain sufficient audio quality.

IP Office supports the DiffServ (RFC2474) QoS mechanism. This is based upon using a Type of Service (ToS) field in the IP packet header. On its WAN interfaces, IP Office uses this to prioritize voice and voice signalling packets. It also fragments large data packets and, where supported, provides VoIP header compression to minimize the WAN overhead.

1.10 Potential VoIP Problems

It is likely that any fault on a network, regardless of its cause, will initially show up as a degradation in the quality of VoIP operation. This is regardless of whether the fault is with the VoIP telephony equipment. Therefore, by installing a VoIP solution, you must be aware that you will become the first point of call for diagnosing and assessing all potential customer network issues.

Potential Problems

- **End-to-End Matching Standards**

VoIP depends upon the support and selection of the same voice compression, header compression and QoS standards throughout all stages of the calls routing. The start and end points must be using the same compression methods. All intermediate points must support DiffServ QoS.

- **Avoid Hubs**

Hubs introduce echo and congestion points. If the customer network requires LAN connections beyond the capacity of the IP Office Unit itself, Ethernet switches should be used. Even if this is not the case, Ethernet switches are recommended as they allow traffic prioritization to be implemented for VoIP devices.

- **Power Supply Conditioning, Protection and Backup**

Traditional phone systems provide power to all their attached phone devices from a single source. In a VoIP installation, the same care and concern that goes into providing power conditioning, protection and backup to the central phone system, must now be applied to all devices on the IP network.

- **Multicasting**

In a data only network, it is possible for an incorrectly installed printer or hub card to multicast traffic without that fault being immediately identified. On a VoIP network incorrect multicasting will quickly affect VoIP calls and features.

- **Duplicate IP Addressing**

Duplicate addresses is a frequent issue.

- **Excessive Utilization**

A workstation that constantly transmits high traffic levels can flood a network, causing VoIP service to disappear.

- **Network Access**

An IP network is much more open to users connecting a new device or installing software on existing devices that then impacts on VoIP.

- **Cabling Connections**

Technically VoIP can (bandwidth allowing) be run across any IP network connection. In practice, Cat5 cabling is essential.

1.11 User PC Connection

To simplify the number of LAN connections from the user's desk, it is possible to route their PC Ethernet LAN cable via most Avaya IP phones.

The LAN cable should be connected from the PC to the socket with a PC symbol (🖨️) at the back of the IP phone. The PC's network configuration does not need to be altered from that which it previously used for direct connection to the LAN. Except for phones with a G suffix, this port supports 10/100Mbps ethernet connections. Phones with a G suffix also support 1000Mbps Gigabit connections.

For phones without a PC port, a separate Gigabit Adapter (SAP 700416985) must be used. This device splits the data and voice traffic before it reaches the phone, providing a 10/100Mbps output for the phone and a 10/100/1000Mbps output for the PC. The adapter is powered from the phone's existing power supply. Refer to the "Gigabit Ethernet Adapter Installation and Safety Instructions" (16-601543).

H323 IP Phones	Supported Models	PC Port	H323 IP Phones	Supported Models	PC Port
1600 Series	1603	–	5600 Series	5601	–
	1603SW	✓		5602	–
	1608	✓		5602SW	✓
	1616	✓		5610SW ^[1]	✓
4600 Series	4601	–		5620	✓
	4602	–		5621SW ^[1]	✓
	4602SW	✓	9600 Series	9620L	✓
	4606	✓		9620C	✓
	4610SW ^[1]	✓		9630G	✓
	4612	✓		9640	✓
	4620	–		9640G	✓
	4620SW	✓		9650	✓
	4621SW ^[1]	✓		9650C	✓
	4624	✓		9608	✓
	4625	✓		9611G	✓
					9621G
				9641G	✓

1.12 Power Supply Options

Each H323 IP phone requires a power supply. They do not draw power from the phone system. Listed below are the power supply options that can be used.

Power over Ethernet (PoE) Options

IEEE 802.3af is a standard commonly known as Power over Ethernet (PoE). It allows network devices to receive power via the network cable using the same wires as the data signals. All the Avaya H323 IP phones supported on IP Office also support this standard.

Where a large number of phones is being installed, the use of PoE switches is recommended. For other scenarios, individual PoE injector devices can be used to add PoE power support to the phone's LAN connection from a non-PoE switch.

H323 IP Phones	Supported Models	802.3af PoE Class		H323 IP Phones	Supported Models	802.3af PoE Class	
		Class	Idle			Class	Idle
1600 Series	1603	2	4.4W	5600 Series	5601	2	3.5W
	1603SW	2	4.4W		5602	1	–
	1608	2	3.7W		5602SW	2	4.1W
	1616	2	2.7W		5610SW	2	3.1W
4600 Series	4601	2	3.5W		5620	3	3.6W
	4602	1	–	5621SW	2	–	
	4602SW	2	3.5W	9600 Series	9620L	1	2.0W
	4606	0	4.1W		9620C	2	3.9W
	4610SW^[1]	2	4.0W		9630G	2	4.6W
	4612	0	4.1W		9640	2	3.9W
	4620	3	4.0W		9640G	2	3.9W
	4620SW	2	–		9650	2	4.7W
	4621SW^[1]	2	5.75W		9650C	2	3.7W
	4624	0	4.1W		9608	1	2.08W
	4625	3	6.45W		9611G	1	2.8W
					9621G	2	3.49W
					9641G	2	3.44W

These 1603 and 1603SW phones require a separate PoE Splitter unit in order to use PoE.

- Exceeding the Class limit of a PoE port or the total Class support of a PoE switch may cause incorrect operation.
- Note that for phones being used with an add-on button module unit, an individual power supply must be used rather than connection to a PoE switch.

1600 Series Phones

These phones can use either PoE as above or can be powered from using 1600 Series plug-top power supply units (PSUs). Different models of PSU exist for the various type of mains power outlets in different countries. The PSU connects to the phone using a barrel connector under the phone.

4600/5600 Series Spare Wire Power Options

The following power supplies use the normally unused pin 7 & 8 connections in the CAT3 or CAT5 network cable. This is referred to as "spare wire" or "mid-span" power supply units. They can be used with 4600 Series and 5600 Series IP phones.

- **Avaya 1151D1 Power Supply Unit (PSU)**

A power supply unit for a single IP phone. Has a LINE port for the LAN cable from the IP Office, and a PHONE port for the LAN cable to the IP phone. Power into the PSU requires a 90 to 264V AC, 47 to 63HZ mains supply. A green LED indicates when power is available.



- **Avaya 1151D2 Power Supply Unit**

Same as the 1151C1 above but with integral battery backup. When AC mains supply is removed, the battery will power the IP phone for between 8 hours at light load (2 Watts) and 15 minutes at full load (20 Watts). A green LED indicates when power is available. A yellow LED indicates when the backup is charging. The green LED flashes when the phone is running from the backup battery.

9600

These phones only support the use of Power over Ethernet (PoE). If not being supplied by a PoE switch, an Avaya Single Port PoE injector (SPPOE-1A) can be used for each phone.

1.13 File Server Options

During installation and maintenance, the phones download various [firmware files](#)^[10]. In order to do this, a phone requests files for an HTTPS server first. If it gets no response, it then tries to obtain the files from an HTTP server. 4600 and 5600 Series phones will then try TFTP. The address of the server to use is provided as part of the DHCP response that the phone received from the DHCP server. If the IP Office system is being used as the DHCP server, the file server address is set as part of the IP Office configuration. For phones installed using static addressing, the file server address is one of the addresses entered during installation.

- Each phone will attempt to request files from the file server every time it is restarted. However, if the phone does not receive any response, it will continue restarting using the existing files that it has in its own memory. Therefore there is no requirement for the file server to be permanently available after initial installation.
 - The IP Office system is currently not supported as a file server for 9608, 9611, 9621, and 9641 phones. This also applies to using the IP Office Manager application acting as the file server. These phones are only supported when using a 3rd-party file server.
- The phones also use a server for the [backup and restoration](#)^[52] of user settings during phone operation. The address for this server is defined by a separate address set found in the **46xxsettings.txt** file. It is not necessarily the same server that is used for the phone firmware. However, for IP Office operation, the address of the IP Office server is recommended for use as the backup/restore file server.

The following options are available for the file server for IP phones being installed on an IP Office system.

File Server	Description	Up to X Phones	TFTP	HTTP	HTTPS
IP Office Manager	When running, IP Office Manager can act as a HTTP/TFTP server for file requests from IP phones.	5	✓	✓	-
IP Office Unit Memory Card	For IP Office control units fitted with an additional memory card, that card can be used to provide the software files. For IP500 V2 control units the System SD card is a mandatory item and is pre-loaded with the phone firmware files during card creation and upgrades. Various other files can be auto-generated ^[22] by the IP Office if not present on the memory card.	50	✓	✓	✓
3rd Party Software	3rd Party HTTP/TFTP file server software is available from many sources including Avaya.	-	✓	✓	✓

Control Unit Memory Card

The memory card used with IP500 and IP500 V2 systems can be used to store files including those used by Avaya IP Phones.

- Non-Avaya supplied Compact Flash memory cards can be used for this type of file storage. However, they will not support embedded voicemail.
- If an Avaya supplied memory card is used, any files stored in this way will reduce the message storage capacity of the Compact Flash memory card.
- The IP500 V2 control unit requires a System SD card at all times. During creation of this card, a full set of IP Office firmware files including those used by Avaya IP phones is placed onto the card.

1.14 File Auto-Generation

For IP Office systems configured to use the system's own memory as the [file server](#)^[21] for the phones, the system will auto-generate the necessary [firmware files](#)^[10] in response to a request from a phone if the actual file is not present in the memory. This feature is used for most of the file types except the .bin firmware files.

- **xxupgrade Files**

The first file that a phone requests when starting up is the **xxupgrade** file. This file contains a list of the phone .bin files that are available as part of the firmware set and the version numbers of those files. If the version of a file differs from that which the phone already has loaded, the phone will request the new file. During this process the phone may reboot after loading each file and then request the xxupgrade.txt file again until it has updated all its firmware, if necessary. Separate files are provided for the different phone series:

- **16xxupgrade.txt**

This file lists the firmware files that 1600 Series phones should load.

- **46xxupgrade.scr**

This file lists the firmware files that 4600 Series and 5600 Series phones should load.

- **96xxupgrade.txt**

This file lists the firmware files that 9600 Series phones should load.

- **96x1Hupgrade.txt**

This file list the firmware files that 9608, 9611, 9621, and 9641 phones should load.

- **46xxsettings.txt**

This file will match the file supplied with the IP Office Manager except:

- The **BRURI** value will be set to indicate the IP Office memory as the file server location for [backup and restore](#)^[52] actions by the phones.
- The **LANG1FILE** to **LANG4FILE** values for 1600 Series and 9600 Series phones for non-English language files is determined from the best match to the system locale and the most common user locales in the IP Office system configuration. Languages currently supported are Dutch, French, French (Canadian), German, Italian, Latin Spanish, Portuguese, Russian, Spanish.

- **Language files**

If the **46xxsettings.txt** file is auto-generated, the matching 1600 Series and 9600 Series phone language files specified in that file are also auto-generated.

- **<ext>_16xxdata.txt**

If the **46xxsettings.txt** file is auto-generated, it will specify the IP Office system as the location for phones to [backup and restore](#)^[52] user settings. If no file exists for a user, a file will be auto-generated. This feature is used for 1600 Series and 9600 Series phones.

In all the cases above, if a matching file is uploaded to the system's memory, the auto-generation of that particular file is overridden.

1.15 Control Unit Memory Card

The memory card used with IP500 and IP500 V2 systems can be used to store files including those used by Avaya IP Phones.

- Non-Avaya supplied Compact Flash memory cards can be used for this type of file storage. However, they will not support embedded voicemail.
- If an Avaya supplied memory card is used, any files stored in this way will reduce the message storage capacity of the Compact Flash memory card.
- The IP500 V2 control unit requires a System SD card at all times. During creation of this card, a full set of IP Office firmware files including those used by Avaya IP phones is placed onto the card.

Chapter 2.

Installation

2. Installation

The following is a summary of the major steps in the installation process. The recommended installation method is to use DHCP where possible, to use the IP Office system as the file server and to enable automatic user and extension creation.

1. IP Office Manager PC

Check that IP Office Manager, System Status Application and System Monitor are installed and can be used to connect to the IP Office system. Verify that you can receive the configuration from the system and send it back.

2. Voice Compression Channels

The IP Office Unit must be fitted with [voice compression channels](#)^[13]. Use either SSA or System Monitor application to verify that the voice compression channels are available. SSA list the VCM channels on the **Resources** screen. The initial lines of Monitor output include the item **VCOMP=** which will state the number of channels installed in the control unit.

3. Avaya IP Endpoint Licenses

Each phone requires an **Avaya IP Endpoint license**^[13]. Phones can register without a license but will not operate. The licenses are added to the IP Office configuration using IP Office Manager.

4. H323 Gatekeeper Settings

The IP Office system has support for H323 phones enabled by default. However, the setting should be checked.

5. DHCP Server Setting

DHCP is the recommended method for installation of IP phones on a IP Office system. This requires a DHCP server configured to support IP phones. The IP Office system can be used for this. If the customer want to use their own DHCP server, it will require [additional configuration](#)^[84].

6. Phone File Server Setting:

If the IP Office system is being used for DHCP, it also needs to be configured with the address of the file server. Whichever installation method and file server is selected, the phone firmware files need to be added to the files available on the server.

7. Extension and User Settings

The IP Office system can be configured to automatically create user and extension entries in its configuration for each IP phone that is installed. If automatic creation is not used, entries must be manually created for each extension and user before the phones are installed.

8. Phone Connections

Once the steps above have been completed, the phones can be connected to the network. If using DHCP, the phones will automatically obtain IP address information and other settings and then start loading files. If not using DHCP, the phones will have to be taken through a manual process of entering the IP address information and settings.

9. Phone Registration

Once the phones have downloaded all the files they require from the file server, they will attempt to register with the IP Office system. The phones will prompt for entry of the extension number that they should use.

10. Testing

Operation of the phones should be tested by making a number of calls, including external calls.

11. Post Installation

If Auto-creation was used for the extension and or user entries, those settings should be disabled after installation of all the phones is completed. This manual only details the minimum user configuration necessary for installation. The new users can now be fully configured to meet the customer requirements for those users.

2.1 Licensing

Refer to the [Licenses](#) ^[13] section for information on licensing rules.

2.1.1 Checking the Serial Number

Licenses are issued against a unique feature key/dongle serial number. For IP500v2 control units that number is unique to the System SD card fitted to the system. For IP500 control units that number is unique to the smart media card inserted in the back of the control unit. For any licenses entered into the system configuration to be valid, they must be licenses issued against that serial number. B5800 Branch Gateway licenses are issued against a unique PLDS Host ID.



1. Using IP Office Manager, retrieve the configuration from the system.
2. Select  **System**.
3. Select the **System** tab.
4. The feature key serial number is shown by the **Dongle Serial Number** field. For B5800 Branch Gateway systems, the PLDS Host ID is indicated by the **PLDS HOST ID** field.
5. This is the number that must be used to obtain licenses for the system. It should also be used to check any licenses received.

2.1.2 Adding Licenses

Use the following procedure to add licenses to the telephone system configuration. You can add multiple (cumulative) licenses.

You must ensure that the licenses match the **Dongle Serial Number** [shown](#) ²⁵ in the system configuration. This should be shown in the file used to supply the licenses. For B5800 Branch Gateway systems, you must ensure that the licenses match the **PLDS Host ID**.

It is recommended that you cut and paste the license keys from a supplied file rather than typing them in manually.

1. Using IP Office Manager, receive the configuration from the telephone system.
2. Select  **License**. The current licenses in the system configuration are displayed.
For B5800 Branch Gateways, select **PLDSLICENSE**.
3. To add a license, click on  and select **License**.
For B5800 Branch Gateway systems, select **PLDSLICENSE** and select **Send PLDS license file to Avaya Branch Gateway**.
4. Enter the license that you have been supplied into the field and click **OK**.
5. The type of the license should be displayed but with its **License Status** set to **Unknown**. If the **License Type** was not recognized, check that it has been entered correctly.
6. Save the configuration back to the system and then receive the configuration from the system again.
7. The **License Status** should now be **Valid**.

2.1.3 Reserving Licenses

This particular process cannot normally be done until the extension entry has been created. If using automatic extension creation (the default), this means that license reservation cannot be done until after initial installation of the phone. However, consideration should be given to using this setting with any existing phones already installed in order to ensure that they retain their licenses if possible following the addition of other phones.

Licenses are normally automatically assigned to extensions in order of registration. However existing extensions can reserve a license in order to ensure they do not become unlicensed when new extensions added to the system manage to register first following a system reboot.

1. Using IP Office Manager, receive the configuration from the telephone system.
2. Select  **Extension** and then select the H323 extension.
3. Select the **VoIP** tab.
4. The **Reserve Avaya IP endpoint license** setting is used to reserve an existing license for the extension.
5. Repeat the process for any other extensions for which you want to reserve the license.
6. Save the configuration back to the telephone system.

2.2 System H323 Support

The IP Office system has H323 support enabled by default. The following sections offer more information on configuring H323 support:

- [Enabling the H323 Gatekeeper](#) ^[27]
- [Setting the RTP Port Range](#) ^[28]
- [Configuring SRTP](#) ^[29]
- [Enabling RTCP Quality Monitoring](#) ^[30]
- [Adjusting Diffserv QoS](#) ^[32]

2.2.1 Enabling the H323 Gatekeeper

Support for H323 telephones and lines is enabled by default. However, the settings should be checked.

Enabling the H323 Gatekeeper

1. Using IP Office Manager, retrieve the configuration from the system.
2. Select  **System**.
3. Select the **LAN1** or **LAN2** tab depending on which of the system's LAN interfaces you want to use to support H323 extensions.
4. Select the **VoIP** sub-tab.

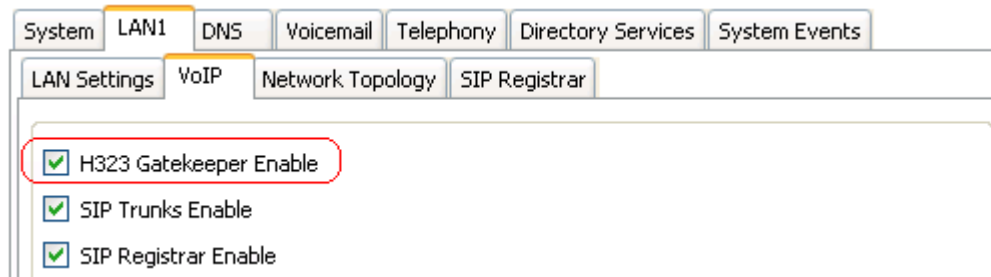

5. Check that the **H323 Gatekeeper Enable** setting is selected.
6. If this setting needs to be changed, save the configuration back to the system.

2.2.2 Setting the RTP Port Range

The ports used for H323 VoIP calls vary for each call. The range for the ports used can be adjusted in order to avoid conflict with other services. If the customer has any internal firewalls or similar equipment that applies port filtering or only forwards traffic based on the port used, the range set here must be allowed by those devices.

For each VoIP call, receive ports are selected from the range defined below. Even numbers in the range are used for the calls incoming Real-Time Transport Protocol (RTP) traffic. The same calls Real-Time Transport Control Protocol (RTCP) traffic uses the RTP port number plus 1, that is the odd numbers.

It is recommended that only port numbers greater than or equal to 49152 but strictly less than 65535 are used, that being the range defined by the Internet Assigned Numbers Authority (IANA) for dynamic usage.

Checking the Port Range

1. Using IP Office Manager, retrieve the configuration from the system.
2. Select  **System**.
3. Select the **LAN1** or **LAN2** tab depending on which of the system's LAN interfaces you want to use to support H323 extensions.
4. Select the **VoIP** sub-tab.

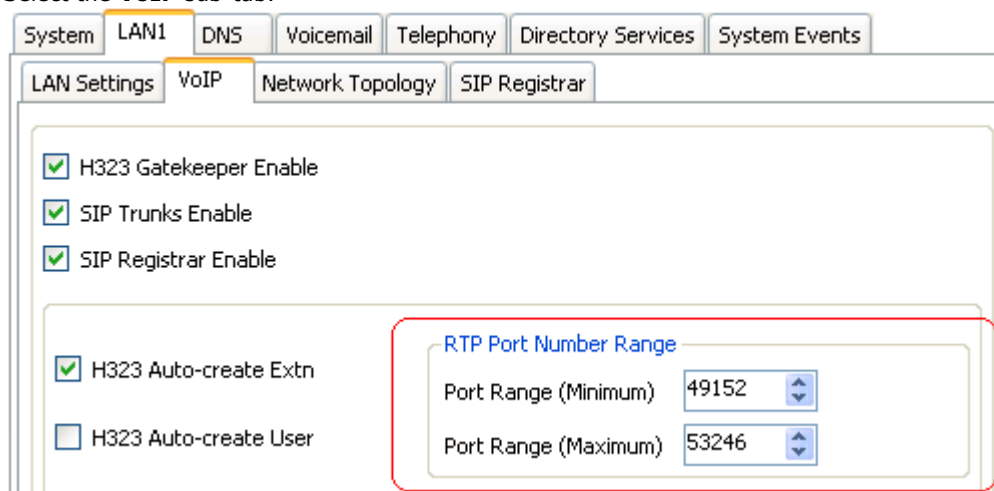

5. Check the **RTP Port Number Range** shown. Remember that the matching RTCP traffic uses the same range plus 1.
 - **Port Range (Minimum):** *Default = 49152. Range = 1024 to 64510.*
This sets the lower limit for the RTP port numbers used by the system. Choosing a minimum range of less than 1024 should only be done after careful analysis of the overall configuration.
 - **Port Range (Maximum):** *Default = 53246. Range = 2048 to 65534.*
This sets the upper limit for the RTP port numbers used by the system.
6. If these settings need to be changed, do so and then save the configuration back to the system.

2.2.3 Configuring SRTP

Avaya B5800 Branch Gateway supports Secure Real-Time Transport Protocol (SRTP) on an optional and per-device basis. A system-wide configuration is available that, by default, is applied to an extension when it is created (this is necessary to provide a default option on media security for all SIP and H323 devices), while configuration for an individual device line takes precedence over system-wide device lines.

Note: A system-wide configuration controls all VoIP extension and line Media Security settings which are set to "System Default."

Calls offering SRTP will be negotiated to a SRTP direct media or relay session if both parties support SRTP. Otherwise, a non-direct media call will be established with one party using SRTP.

1. Using IP Office Manager, retrieve the configuration from the system.

2. Select  **System**.

3. Select the **Telephony** tab.

Two new drop-down menus are available: **Media Security (SIP)** and **Media Security (H323)**. The default selection for SIP is "Prefer" while for H323 it is "Disable."

Note: For IPO mode, the default selection is set to "Disable" for both drop-down menus.

4. From each drop-down menu select either "Disable" or "Enforce."

This configuration determines the default selection of the Media Security option in a new VoIP extension or Trunk. For more information, see the 'SRTP Configuration Table' below.

SRTP Configuration Table

The configuration options for Media Security are offered at the device level and also at the system level. The settings at the system level determine the setting for a device connection.

Configuration	Detail	Availability
Disable	<p>This setting for any IP endpoint or SIP line/SM line implies that this entity does not or cannot support SRTP. In case of VoIP endpoints, when the gateway relays the media, it will send and receive RTP packets to this endpoint (and depending on the connection, it may encrypt the packets for transmission to the other end of the call).</p> <p>In case of trunks, (SIP line and SM line), the gateway will not advertise support for SRTP and will reject incoming offers proposing only secure media capabilities.</p>	<ul style="list-style-type: none"> • SIP • H323
Enforce	<p>This setting implies that the gateway will send and receive only secure media streams from this endpoint. For a SIP line or SM line, this configuration implies that if an incoming offer does not contain SRTP capabilities, then the call will be rejected.</p> <p>Likewise, all outgoing offers on this trunk will offer only secure media capabilities.</p>	<ul style="list-style-type: none"> • SIP • H323

2.2.4 Enabling RTCP Quality Monitoring

Avaya IP phones support call quality monitoring. This is done using port 5005 both on the system and the phones. Enabling the option below instructs the phones to provide call quality information to the IP Office system on that port.

Enabling RTCP monitoring provides the system with measures of packet delay, packet loss and jitter. That information can be accessed using the System Status Application and IP Office System Monitor applications. The system can also be configured to output alarms when the call quality values exceed set levels.

Enabling the RTCP Quality Monitoring

1. Using IP Office Manager, retrieve the configuration from the system.
2. Select  **System**.
3. Select the **LAN1** or **LAN2** tab depending on which of the system's LAN interfaces you want to use to support H323 extensions.
4. Select the **VoIP** sub-tab.

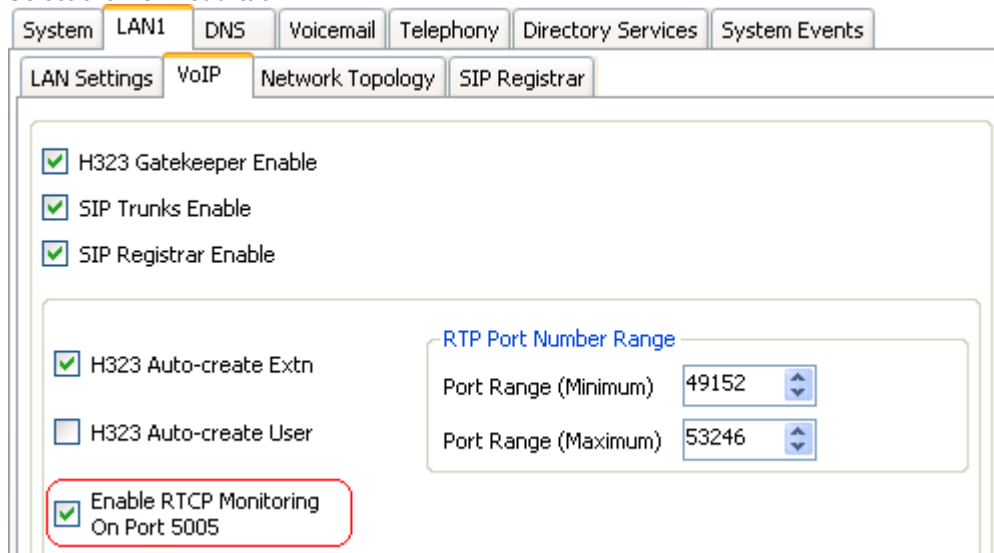

The screenshot shows the IP Office Manager configuration interface. The top navigation bar includes tabs for System, LAN1, DNS, Voicemail, Telephony, Directory Services, and System Events. The LAN1 tab is selected, and the sub-tabs are LAN Settings, VoIP, Network Topology, and SIP Registrar. The VoIP sub-tab is active, displaying several configuration options:

- H323 Gatekeeper Enable
- SIP Trunks Enable
- SIP Registrar Enable
- H323 Auto-create Extn
- H323 Auto-create User
- Enable RTCP Monitoring On Port 5005 (highlighted with a red box)

There is also an RTP Port Number Range section with two spinners: Port Range (Minimum) set to 49152 and Port Range (Maximum) set to 53246.

5. Check that the **H323 Gatekeeper Enable** setting is selected.
6. If this setting needs to be changed, save the configuration back to the system.

Setting the Quality of Service Alarm Levels

The system can send alarms to the System Status Application. It can also send the same alarms to SNMP, emails or Syslog destinations. For details of how to configure these refer to the IP Office Manager documentation. The settings below are used to set the levels which, if exceeded, will cause an alarm to be sent at the end of a call.

1. Using IP Office Manager, retrieve the configuration from the system.

2. Select  **System**.

3. Select the **System Events** tab and then the **Configuration** sub-tab.

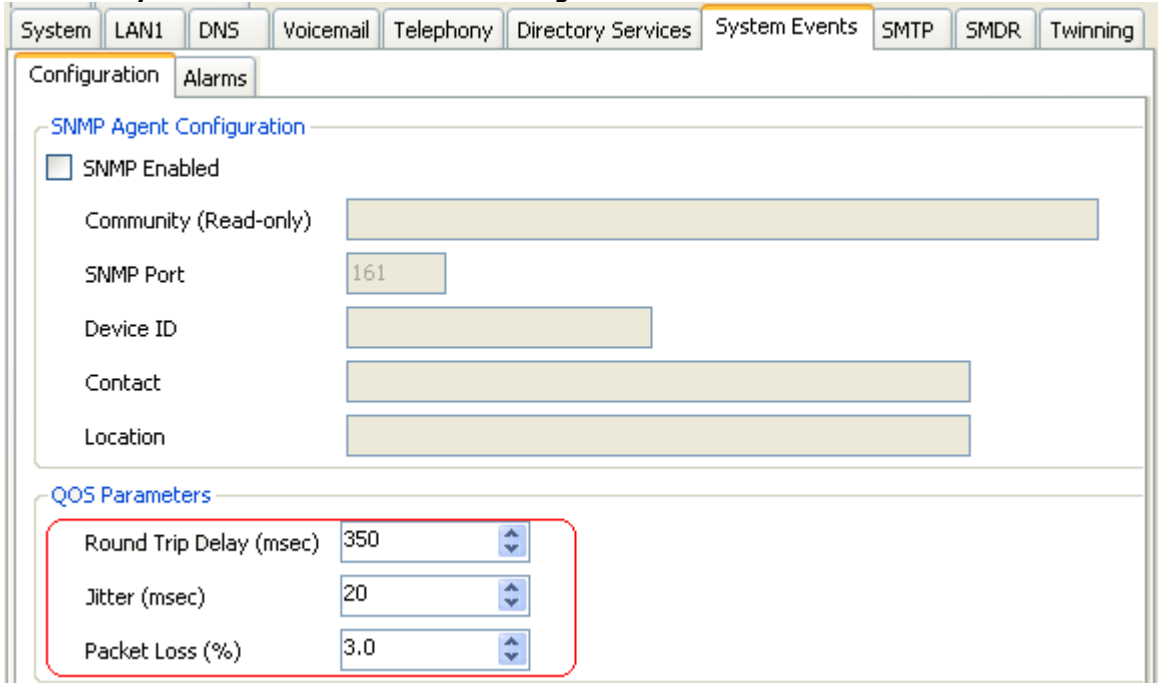

The screenshot shows the IP Office Manager configuration interface. The top navigation bar includes tabs for System, LAN1, DNS, Voicemail, Telephony, Directory Services, System Events, SMTP, SMDR, and Twinning. The System Events tab is selected, and the Configuration sub-tab is active. The configuration is divided into two sections: SNMP Agent Configuration and QoS Parameters. The QoS Parameters section is highlighted with a red box and contains the following settings:

Parameter	Value
Round Trip Delay (msec)	350
Jitter (msec)	20
Packet Loss (%)	3.0

4. The QoS Parameters are used by the system to trigger alarms. The default settings match the limits usually acceptable for good call quality,

5. If the settings are adjusted, save the configuration back to the IP Office system.

2.2.5 Adjusting DiffServ QoS

DiffServ is used to apply different 'quality of service' tags to the voice (RTP) and control signal (RTCP) elements of a VoIP call. The IP Office system itself does not apply any different priority to data packets its receives or sends based on their tags. However, when being used in a network where QoS is being used for prioritization by other devices, the IP Office's settings should be set to match those expected for voice calls and their associated control signalling.

Enabling the DiffServ QoS Settings

1. Using IP Office Manager, retrieve the configuration from the system.

2. Select  **System**.

3. Select the **LAN1** or **LAN2** tab depending on which of the system's LAN interfaces you want to use to support H323 extensions.

4. Select the **VoIP** sub-tab.

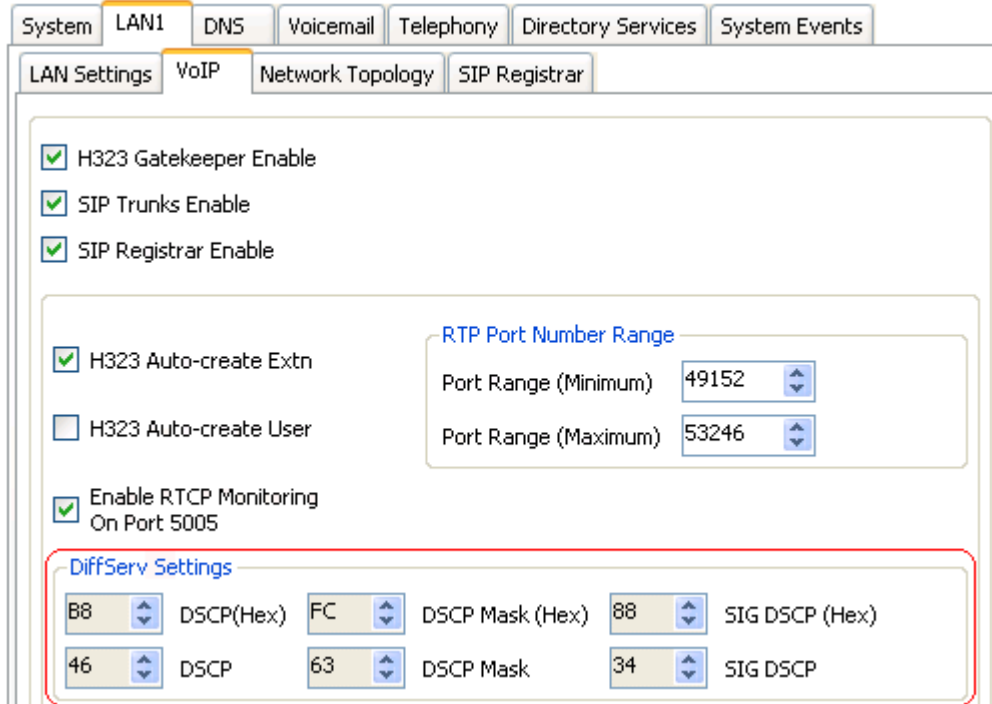

The screenshot shows the IP Office Manager configuration interface. The 'System' tab is selected, and the 'LAN1' sub-tab is active. The 'VoIP' sub-tab is selected, and the 'DiffServ Settings' section is highlighted with a red box. The 'DiffServ Settings' section contains two rows of settings:

Setting	Value
DSCP(Hex)	B8
DSCP	46
DSCP Mask (Hex)	FC
DSCP Mask	63
SIG DSCP (Hex)	88
SIG DSCP	34

5. Check the **DiffServ Settings** that are being used by the system. Note that the 2 rows are linked, the upper row shows the DiffServ values in Hex numbers, the lower row shows the values in decimal. The hex values are equal to the decimal multiplied by 4. Either row can be used to set the required values.

6. If these settings need to be changed, do so and then save the configuration back to the system.

2.3 DHCP Settings

The recommendation for H323 phone installation is to use DHCP, especially if a large number of phones are being installed. Using DHCP simplifies both the installation and maintenance.

There are a number of options around which server is used for the DHCP support for the H323 phones:

- If the IP Office system is to be used as a DHCP server for the network, use the processes below to check and configure the system's DHCP settings.
- If a separate DHCP server is used by the customer's network, that DHCP server may need to be configured to support DHCP requests from IP phones, see [Alternate DHCP Server Setup](#)^[84].
- The IP Office can be configured to only provide DHCP support for Avaya phones. That option can be used to allow it to be used in conjunction with a separate customer DHCP server. This removes the need to configure the customer's DHCP server for IP phone support.

- **! WARNING**

Enabling an additional DHCP server in a network can cause connection issues for all devices on the network. Ensure that you, the user, and the user's network administrator all agree upon the correct choice of DHCP server option.

Enabling IP Office DHCP Support

The following are the main steps for enabling the IP Office system to support DHCP operation for IP phones.

1. [Enable DHCP and Set the Number of Addresses](#) ^[35]
2. [Check the Site Specific Option Numbers](#) ^[36]
The IP Office defaults match the defaults used by Avaya IP phones. However it is important to check these values and to be aware of their potential usage.
3. [Set the File Server Settings](#) ^[37]
If the IP Office system is set to provide DHCP for IP phones, that role includes telling the phones the location of the file server they should use for phone firmware, even if that file server is not the IP Office system.

2.3.1 System DHCP Support

- Using IP Office Manager, retrieve the configuration from the system.
- Select  **System**.
- Select the **LAN1** or **LAN2** tab depending on which of the system's LAN interfaces you want to use to support H323 extensions.
- Select the **LAN Settings** tab.

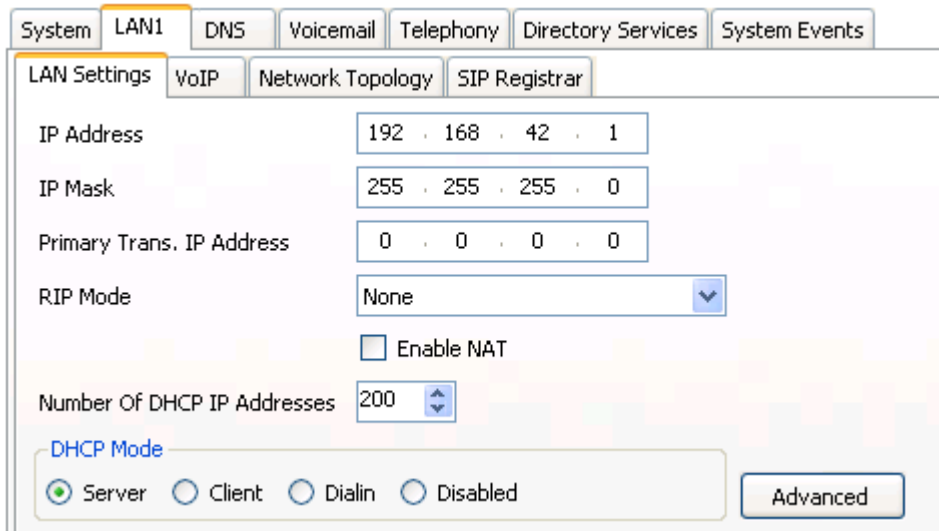

System | **LAN1** | DNS | Voicemail | Telephony | Directory Services | System Events

LAN Settings | VoIP | Network Topology | SIP Registrar

IP Address: 192 . 168 . 42 . 1

IP Mask: 255 . 255 . 255 . 0

Primary Trans. IP Address: 0 . 0 . 0 . 0

RIP Mode: None

Enable NAT

Number Of DHCP IP Addresses: 200

DHCP Mode: Server Client Dialin Disabled

Advanced

- If the **DHCP Mode** is set to **Server**, the **Number of DHCP IP Addresses** value set how many IP addresses the system can issue. Those addresses are use the IP Address of the system as the starting point.
- Click the **Advanced** button or select the **DHCP Pools** tab if already visible.

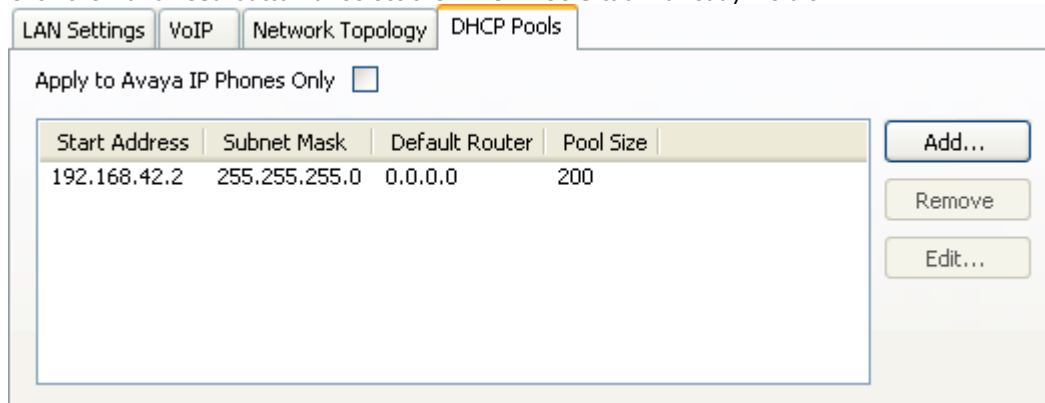

LAN Settings | VoIP | Network Topology | **DHCP Pools**

Apply to Avaya IP Phones Only

Start Address	Subnet Mask	Default Router	Pool Size
192.168.42.2	255.255.255.0	0.0.0.0	200

Add...
Remove
Edit...

- The settings on this tab allow adjustment of the DHCP setting including adding multiple ranges of DHCP numbers that the IP Office system can support. Note that address ranges outside those of the IP Office systems own subnet may also require the creation of appropriate IP routes to ensure traffic routing between the subnets.
- If the **Apply to Avaya IP Phone Only** option is selected, the IP Office will act as a DHCP server for Avaya phones only. This option cannot be used if also supporting 1100 Series and 1200 Series phones.
- If the settings have been changed, save the configuration back to the system.

2.3.2 System Site Specific Option Numbers

When requesting address settings from a DHCP server, each phone also requests additional information that the DHCP server may have. It does this by sending a Site Specific Option Number (SSON). If the DHCP server has information matching the SSON, that information is included in the DHCP response.

4600 and 5600 Series phones use 176 as their default SSON. 1600 and 9600 Series phones use 242 as their default SSON. However, through the phone's own menus the [SSON it uses can be altered](#)^[73]. For those phones using the IP Office system for DHCP, the SSON numbers that the IP Office supports are set in the IP Office system's configuration. The values used by the phones and supported by the IP Office system must match.

Changing the Systems SSON Settings

1. Using IP Office Manager, retrieve the configuration from the system.
2. Select  **System**.
3. Select the **LAN1** or **LAN2** tab depending on which of the system's LAN interfaces you want to use to support H323 extensions.
4. Select the **VoIP** sub-tab.

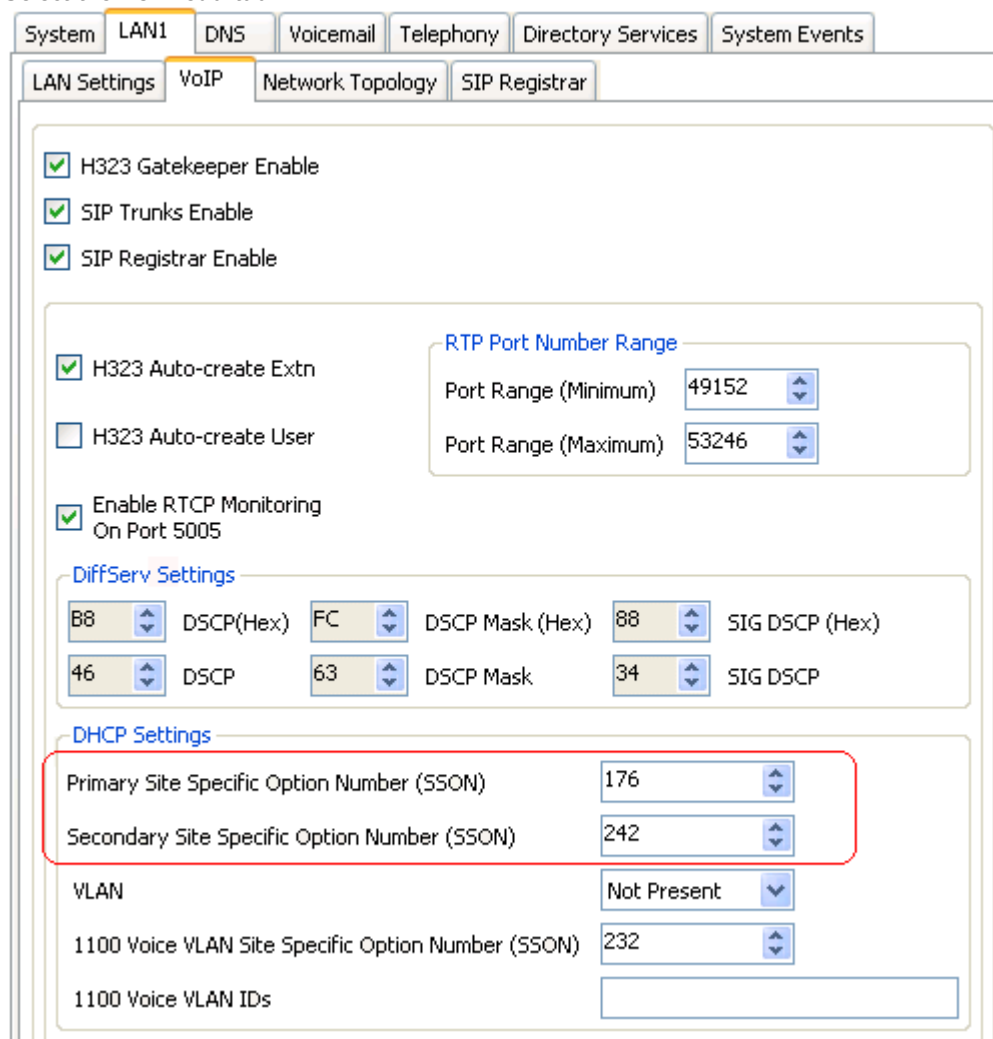

The screenshot shows the IP Office Manager configuration interface. The 'System' tab is selected, and the 'LAN1' sub-tab is active. Within the 'LAN1' sub-tab, the 'VoIP' sub-tab is selected. The configuration page includes several sections: 'H323 Gatekeeper Enable', 'SIP Trunks Enable', and 'SIP Registrar Enable' (all checked). 'H323 Auto-create Extn' is checked, and 'H323 Auto-create User' is unchecked. 'Enable RTCP Monitoring On Port 5005' is checked. The 'DiffServ Settings' section includes dropdowns for DSCP (Hex) (B8), DSCP Mask (Hex) (FC), DSCP (46), and DSCP Mask (63). The 'SIG DSCP (Hex)' is set to 88, and the 'SIG DSCP' is set to 34. The 'DHCP Settings' section is highlighted with a red box and contains: 'Primary Site Specific Option Number (SSON)' set to 176, 'Secondary Site Specific Option Number (SSON)' set to 242, 'VLAN' set to 'Not Present', '1100 Voice VLAN Site Specific Option Number (SSON)' set to 232, and '1100 Voice VLAN IDs' set to an empty field.

5. Check that the Site Specific Option Number settings match those required for the phone being supported. The default for 4600 and 5600 Series phones is 176. The default for 1600 and 9600 Series phones is 242.
6. If this setting needs to be changed, save the configuration back to the system.

2.4 File Server Settings

As part of the installation process, the phone will request files from a file server. If being installed using DHCP, they obtain the address of the file server as part of the DHCP response from the DHCP server. If being statically installed, the file server address is entered into the phone as part of the static addressing process.

The file server options are:

- The IP Office system's own memory card can be used as the source for the files used by the 1100/1200 Series phones. This is the recommended option and can be used for up to 50 phones.
- The IP Office Manager application can also act as a file server for up to five (5) phones.
- If either of the options above are not acceptable, a 3rd party HTTP file server is required. The necessary phone firmware files then need to be loaded onto that server.

2.4.1 System File Server Settings

If the IP Office system is being used for [DHCP support](#)^[33] for the IP phones, various settings in the IP Office system's configuration are used to set the file server addresses sent to the phones in the DHCP responses.

1. Using IP Office Manager, retrieve the configuration from the system.

2. Select  **System**.

3. Select the **System** tab.

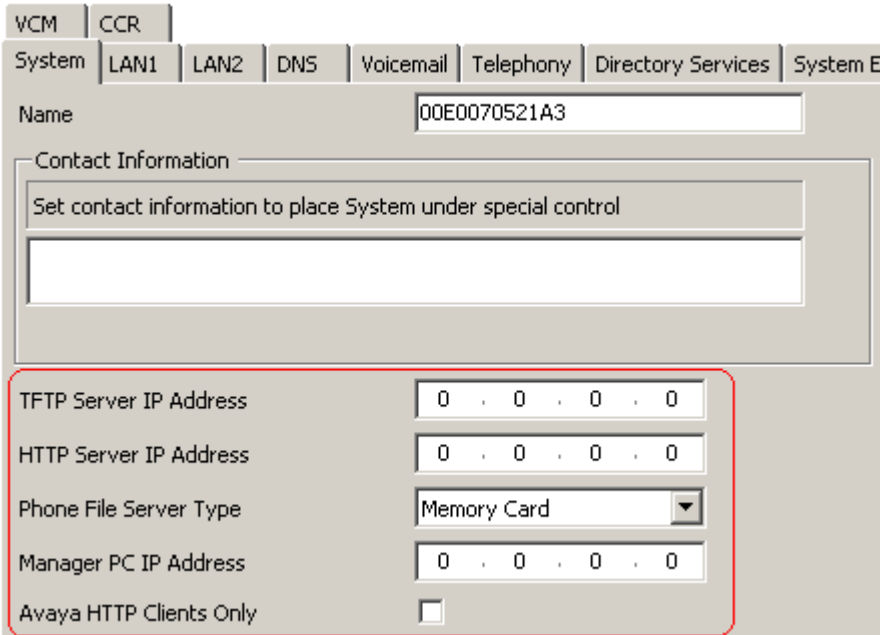

4. Check the **Phone File Server Type** setting.

- **Memory Card**

Use the systems own memory card by providing its own IP address as the TFTP and HTTP file server values in the DHCP response. This is the default setting.

- **Manager**

Use the IP Office Manager application as the TFTP and HTTP file server. This option is only supported for a maximum of 5 IP phones. This option uses the separate **Manager PC IP Address** set in the configuration. The default of 0.0.0.0 is used by the system to broadcast for any available IP Office Manager application on the network.

- **Custom**

This option uses the separate **TFTP Server IP Address** and **HTTP Server IP Address** values set in the configuration as the files server addresses in the DHCP response given to phones.

- The **TFTP Server IP Address** default of 0.0.0.0 is a broadcast on the network for a TFTP server.
- The **HTTP Server IP Address** default of 0.0.0.0 is no HTTP request.

5. The **Avaya HTTP Clients Only** option can be used to restrict the system to responding to file requests from Avaya phones and applications only. This option should not be used if the system is also supporting 1100 and or 1200 Series phones.

6. If any changes have been made, save the configuration back to the system.

2.4.2 Creating/Editing the Settings File

During installation, the phones request files first downloading an **xxupgrade** file from the file server. They then follow the instructions within that file to request further files if necessary. Various different xxupgrade files exist for the different phone series. These are provided as part of the [phone firmware](#)^[10]. The xxupgrade files should not be edited or changed in any way.

The last line of all the xxupgrade files instructs the phones to request the **46xxsettings.txt** file. This file can be used to set site specific settings for all the Avaya H3232 IP phones being supported on a particular site.

When using the IP Office system as the file server, the IP Office system will [auto-create](#)^[22] a suitable **46xxsettings.txt** file based on various IP Office system configuration settings. It will only do this if there is no actual **46xxsettings.txt** file available on the server.

Manually Editing the File

1. Locate the **46xxsettings.txt** file on the file server.
2. Using Windows Notepad or any other plain text editing tool, open the **46xxsettings.txt** file.
3. Edit the file as required. The file contains numerous comments and notes. Further details of the various settings are contained in the appropriate LAN Administrator Manual. This manual only contains a limited number of examples of the settings available. Note also that the files contain a wide range of settings used on other Avaya telephone systems that may not work with IP Office systems.
 - [9600 Series IP Telephones Administrator Guide](#) (16-300698)
 - [4600 Series IP Telephone LAN Administrator Guide](#) (555-233-507)
 - [1600 Series IP Telephones Administrators Guide](#) (16-601443).
4. A # character at the start of a line comments out the command on that line. Note however that for some options the phones will assume a default value if the option in the **46xxsettings.txt** file is commented out. For example if **SET PHNOL** is commented out, the phones will assume the addition of a **dial 9** prefix to numbers.

Dialing Prefix

For IP Office systems the addition or removal of dialing prefixes is normally done by the IP Office system rather than individual phones or applications. For IP Office operation the following changes are recommended in the **ENHANCED LOCAL DIALING RULES** section of the **46xxsettings.txt** file.

- Change ## **SET ENHDIALSTAT 0** to **ENDIALSTAT 0**.
- Change ## **SET PHNOL 9** to **SET PHNOL ""**.

802.1Q Tagging

Unless specifically required for the customer network, for IP Office operation it is recommended that ## **SET L2Q 0** is changed to **SET L2Q 2**.

WML Web Server Setup

If a WML web site has been setup for viewing by phone users, see [WML Server Setup](#)^[92], the site address is set through the **46xxsettings.txt** file. Change ## **WMLHOME http://.....** to **WMLHOME** followed by the required address.

1600/9600 Series Phone Languages

In addition to English, the 1600 and 9600 phones can support up to four (4) other languages. This is done by the phones, which download the language files specified in the **46xxsettings.txt** file. Currently nine (9) non-English language files are provided as part of the IP Office Manager installation.

Language	1600 File	9600 File
Dutch	mlf_dutch.txt	mlf_9600_dutch.txt
French Canadian	mlf_french_can.txt	mlf_9600_french_can.txt
French	mlf_french_paris.txt	mlf_9600_french_paris.txt
German	mlf_german.txt	mlf_9600_german.txt
Italian	mlf_italian.txt	mlf_9600_italian.txt
Portuguese	mlf_portuguese.txt	mlf_9600_portuguese.txt
Russian	mlf_russian.txt	mlf_9600_russian.txt
Spanish	mlf_spanish.txt	mlf_9600_spanish.txt
Spanish (Latin American)	mlf_spanish_latin.txt	mlf_9600_spanish_latin.txt

The files to download to the phones are defined in the # **SETTINGS1603**, # **SETTINGS1608** and # **SETTINGS1616** sections of the **46xxsettings.txt** file. To have the phone download a language file, remove the ## in front of one of the **SET** options and change the file name to match the required language. If using the IP Office system as the file server, the appropriate language files based on the IP Office system configuration can be provided using [file auto-generation](#) ^[22].

Backup/Restore

Phones can use an HTTP server as a location to which the user's phone settings are backed up and restore when they log on or off the phone. See [Backup/Restore Settings](#) ^[52] for full details.

2.4.3 Loading Software Files onto the System

The phone firmware suitable for IP Office system operation is supplied as part of the IP Office Manager software and is copied onto the PC when IP Office Manager is installed. No other firmware should be used with IP Office unless specifically documented.

There are a number of methods by which the firmware installed with IP Office Manager can be copied onto the telephone system's memory card. The method used depends mainly on the type of control unit.

- **! WARNING**

A memory card should never be removed from a running system without either the card or the system first being shutdown. IP Office Manager should be used to shutdown the memory card before it is removed from the system.

- For IP Office operation, only the phone .bin files need to be present on the memory card. Other files required by the phones are automatically generated by the system in response to requests from the phones.

IP500 V2 Control Unit

The system's System SD card is used to store the files. This is a mandatory card that is present in all IP500 V2 systems. The firmware files are loaded onto the card in a number of ways:

- If the system was upgraded using the **Recreate SD Card** option in IP Office Manager, the firmware is automatically copied onto the card as part of that process.
- If the system was upgraded using IP Office Manager's Upgrade Wizard, if the **Upload System Files** option was selected, the firmware is copied onto the card as part of that process. The **Upload System Files** option is enabled by default.

IP500 Control Unit

The compact flash memory card is used to store the files. This is an option card that may only be present if the system is using embedded voicemail. The files need to be copied manually onto the memory card. This can be done in a number of ways:

- Files can be copied remotely onto the card in a running system using IP Office Manager's embedded file management.
- The card can be shutdown and removed from the system. Files can then be copied onto the card using a PC with a suitable memory card slot.

If you think the correct files are not present, you can use the embedded file manager part of IP Office Manager to check the files on the card and to copy the files onto the card if necessary.

Using Embedded File Manager to Check/Upload Files

Embedded file manager allows you to remote see the files on the memory card used by the telephone system. It also allows you to upload new files.

1. In IP Office Manager, select **File | Advanced | Embedded File Management**.
2. The **Select IP Office** menu is displayed.
3. Select the telephone system and click **OK**.
4. Enter the name and password for the system. These are the same as used for configuring the system.

5. The contents of the memory card are displayed.

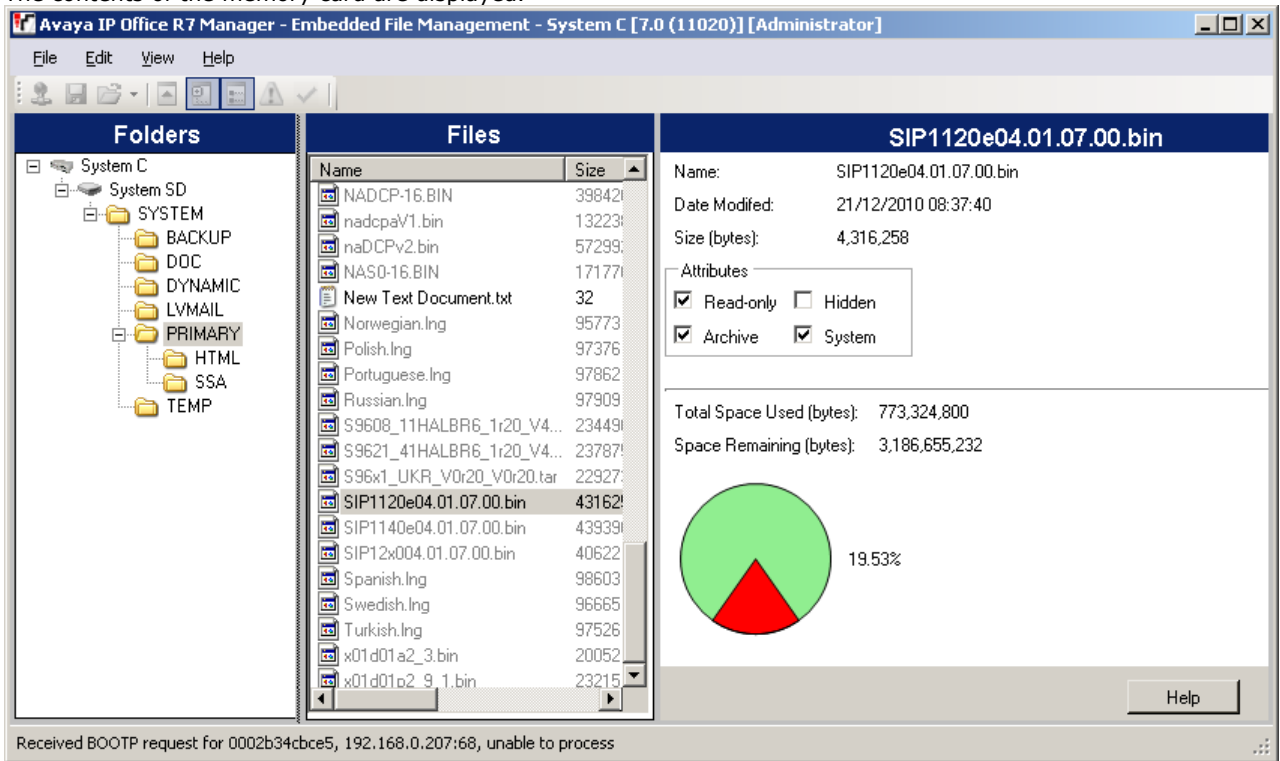

6. For an IP500 memory card, all the firmware files are held in the top level folder. For an IP500 V2 system, use the folder tree to navigate to **System SD | SYSTEM | PRIMARY**.

7. Individual files can be copied onto the card by using drag and drop or by selecting **File | Upload File (IP500)** or **File | Upload System Files (IP500 V2)**. The whole set of phone firmware files that IP Office Manager has available can be copied by selecting **File | Upload Phone Files**.

- The source files can be found on the IP Office Manager PC in **C:\Program Files\Avaya\IP Office\Manager\memory Cards\Common\system\primary**.

Manually Copying Files

Files can be copied onto the memory card by placing it into a PC with a suitable memory card slot.

- **! WARNING**

A memory card should never be removed from a running system without first being shutdown. IP Office Manager should be used to shutdown the memory card before it is removed from the system.

1. Using IP Office Manager, select **File | Advanced | Memory Card Command | Shutdown**.
2. The **Select IP Office** menu is displayed.
3. Select the telephone system and click **OK**.
4. Enter the name and password for the system. These are the same as used for configuring the system.
5. You may be prompted for which card you want to shutdown. Select **System** and click **OK**.
6. On the back of the control unit, check that the LED for the memory card slot is off before removing the memory card.
7. Place the card into the PC's memory card slot and examine the contents.
8. For an IP500 memory card, all the firmware files are held in the top level folder. For an IP500 V2 system, use the folder tree to navigate to **System SD | SYSTEM | PRIMARY**. The source files can be found on the IP Office Manager PC in **C:\Program Files\Avaya\IP Office\Manager\memory Cards\Common\system\primary**.
9. When the card is reinserted into the system, card usage is automatically restarted.

2.4.4 Loading Files onto a 3rd Party Server

The phone firmware files are installed as part of the IP Office Manager application and are found in the application's installation directory. By default, the directory is found at **c:\Program Files\Avaya\IP Office\Manager**.

The same firmware files can also be obtained directly from the software package used to install IP Office Manager without having to perform the installation. The files are located in the **\program files\Avaya\IP Office\Manager** sub-folder of the installation directory.

Note that these sets of files include .bin files that are also used for other devices including the IP Office system itself.

2.5 User and Extension Creation

When a new H323 telephone registers with the system, the IP Office can automatically create a new extension entry for the telephone in its configuration. It can also automatically create a new user entry for the telephone. Alternatively if the phone registers using an extension number for which entries already exist, those entries are used so long as no other phone is already using them.

For new installations, the use of Auto-creation is recommended for ease of installation. The auto-create options can be disabled after installation. If Auto-creation is not used, extension and user entries need to be manually added to the configuration before attempting to install the phones.

Note: Auto-creation is not supported on B5800 Branch Gateway systems.

2.5.1 Auto-Creation

We recommend that you use Auto-creation to create extensions and user entries. The settings can be disabled after installation.

Note: Auto-creation is not supported on B5800 Branch Gateway systems.

Switching Auto-Create On/Off

1. Using IP Office Manager, receive the configuration from the system. Select  **System**.
2. Select the **LAN1** or **LAN2** tab depending on which of the system's LAN interfaces you want to use to support H323 extensions.
3. Select the **VoIP** sub-tab.

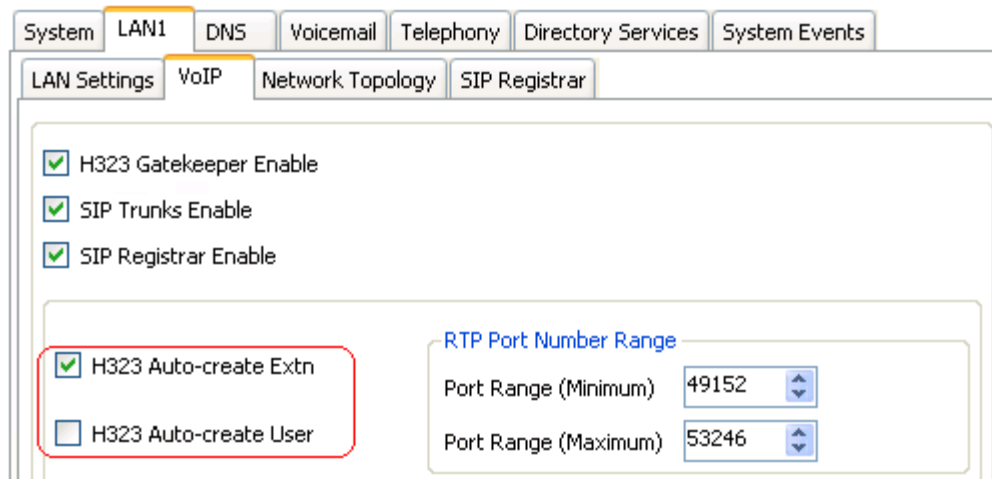

The screenshot shows the configuration interface for the VoIP sub-tab. The 'LAN1' tab is selected, and the 'VoIP' sub-tab is active. The 'H323 Auto-create Extn' checkbox is checked and highlighted with a red box. The 'H323 Auto-create User' checkbox is unchecked. The RTP Port Number Range is set from 49152 to 53246.

4. The **H323 Auto-create Extn** and **H323 Auto-create User** settings are used for H323 phone installation. Set these as required for the installation. If either option is not enabled, it will be necessary to [manually create the extension entries](#) ^[46] and or [manually create the user entries](#) ^[46] before installing the phones.
5. If the settings have been changed, save the configuration back to the system.

2.5.2 Manually Creating User

If the **Auto-create User** option is [not enabled](#)^[45], you must manually create a user entry for each phone being installed. Use the procedure below to manually create an entry. It will also prompt whether a matching extension entry should also be created.

Manually Creating User Entries

- Using IP Office Manager, retrieve the system's configuration.
- To display the list of existing users, click  **User** in the left-hand panel. Right-click on the right-hand panel and select **New**.
 - In the **User** tab set the following:
 - Name**
Enter a name for the extension user. The name must be unique. If voicemail is in use, this name will be used as the basis for a new mailbox with matching name.
 - Extension**
This must match the extension number.
 - Click on the **Button Programming** tab. For the first three buttons, you must click on the **Action** field and select **Appearance | Appearance**.
 - Click on **OK**.
 - IP Office Manager will prompt whether it should also create a matching extension. If the **Auto-create Extn** option is not enabled, select **H323 Extension** and click **OK**. Otherwise, select **None** and click **OK**.
- Save the configuration changes back to the system.

2.5.3 Manually Creating Extensions

If the **Auto-create Extn** option is [not enabled](#)^[45], you must manually create an extension entry for each phone being installed. This can be done either as part of the process of [manually creating users](#)^[46] or it must be done separately using the process below.

Manually Creating Extension Entries

- Using IP Office Manager, retrieve the system's configuration.
- To display the list of existing extensions, click  **Extension** in the left-hand panel. Right-click on the right-hand panel and select **New**.
 - In the **Extn** tab, set the following:
 - Extension ID**
For a VoIP extension, enter any number so long as it is unique, i.e. not already used by another extension.
 - Base Extension**
Enter the extension number to assign to the phone. Again, this must be unique. This value is used to associate the extension with the user who has the same extension number.
 - To add the new extension, click **OK**.
- Save the configuration changes back to the system.

Codec Selection

If the **Codec Selection** is left set to **System Default**, the extension will use the system codec preferences. In most cases this is preferred and any changes required should be made at the system level to ensure consistency for all IP trunks and extensions.

However, if required, the **Codec Selection** of each individual trunk and extension can be adjusted to differ from the system defaults.

- Using IP Office Manager, retrieve the system's configuration.
- To display the extension's settings, click  **Extension** in the left-hand panel.
- Select the **VoIP** tab.
- Change the **Codec Selection** to **Custom**.

5. The **Used** and **Selected** lists can be used to select which codecs the device uses and their order of preference.
6. Save the configuration changes back to the system.

2.6 Phone Connection

In this process the phone is connected to its power source and to the ethernet LAN. As soon as the phone is powered up it will start to request information.



1. Do not start this process until all the preceding steps in the [Installation Summary](#)^[24] have been completed.
2. Connect the network LAN cable to the data-in socket of the power supply being used for the phone.
3. Connect the LAN cable supplied with the IP phone from the power supplies data and power out socket to the socket with a LAN port symbol (□) at the back of the IP phone.
4. The phone's message indicator should glow red for a few seconds. The phone will then begin its software loading process. After a short delay, the phone displays **Initializing** and then **Loading...** The loading phase may take a few minutes.
 - If the phone has an existing software boot file (ie. it has been previously installed), it will load that file and then display **Starting...**
 - If the phone displays **No Ethernet**, check the connection to the LAN.
5. The phone displays **DHCP** and a timer as it attempts to request an IP address and other information from a DHCP server.
 - **To switch to static address installation**
Press * whilst DHCP is shown. See [Static Address Installation](#)^[49].
6. After a few seconds, DHCP negotiation should be completed. If the timer reaches more than 60 seconds, it could indicate an error in either the network or DHCP server configuration.
7. Once DHCP has completed successfully, the phone will request files from the file server indicated in the DHCP response. The first file requested details the other files that the phone should also load. The phone will first make its file request using HTTPS. If this fails it will make the same request using HTTP. If that fails it will make a final request using TFTP. If all requests for a file fail, the phone will fallback to using the current version of the file it has in its own memory.
8. The phone will go through a cycle of requesting files, loading files and then transferring the files into its flash memory.
9. Following file loading, the phone displays **Ext. =**. See [Phone Registration](#)^[51].

2.7 Static Address Installation

Static addressing is only necessary when a DHCP server is unavailable or not desired. For ease of maintenance and installation, it is strongly recommended that a DHCP server used and that static addressing is avoided. Following any boot file upgrade of the phone's firmware, static address information may require reinstallation.

The use of static address installation is not supported with 4601 and 5601 phones.

1600, 4600 and 5600 Series Phones

1. Follow the steps in [Phone Connection](#)^[48] until **DHCP** is shown on the phone display. Press * at this point to switch the phone to static address installation. Existing 4600 and 5600 Series phones can be made to start static address installation while idle by pressing **MUTE 2 3 3 7 # (MUTE A D D R #)**.
2. The phone will display a sequence of settings and the existing value for each of those settings. To accept the current value, press # or enter a value and then press #.
3. While entering data in the following actions it may sometimes be necessary to backspace. The method for doing this varies according to the phone type:
 - **4602, 5602:**  Speaker key.
 - **4606:**  Conference key.
 - **4612 & 4624:**  Previous key.
 - **4610, 4620, 4625, 5610, 5620:** Left-most key.
4. The settings shown for static address installation are:
 - **Phone =**
This is the phone's IP address. To accept the current value, press # or enter a value and then press #. If entering a new value, press the * key to enter a '.' character between digits.
 - **CallSv =**
This is the address of the H323 gatekeeper. For IP Office systems this is the IP address of the IP Office LAN.
 - **CallSvPort =**
This is the Gatekeeper transport layer port number. For Avaya IP phones the value used should be **1719**. To accept the current value, press # or enter a value and then press #.
 - **Router =**
This is the address of the phone's default IP gateway. For IP Office this is typically the IP address of the IP Office LAN. To accept the current value, press # or enter a value and then press #.
 - **Mask =**
This is the phone's IP Mask (also called the subnet mask). The mask is used with the IP address to indicate the phone's subnet. This should match the IP mask set for the IP Office Unit.
 - **FileSv =**
This is the address of the file server from which the phone should request software and settings files. Enter the address of the TFTP or HTTP configured with the Avaya IP phone software file set.
 - **802.1Q =**
To change the setting press *. Press # to accept the value.
 - **VLAN ID =**
For details of VLAN configuration see [VLAN and IP Phones](#)^[59].
5. If you go through without changing anything, the phone displays **No new values**. Press #. If the phone displays **Enter command**, power off and on again.
6. Once all the values have been entered or the existing values accepted the phone will display **Save new values?**. To save the values, press #. The phone will save the values and then restart using those values.
7. The [phone registration](#)^[51] menu is displayed.

9600 Series Phones

1. When the option **Press * to program** is displayed, press the * key.
2. When **Enter code** is displayed, enter the administrative procedures passcode and press #. The default passcode is **CRAFT (2 7 2 3 8)**.
3. Scroll the menu to **ADDR** and select this option to start the address procedure.
4. The list of required addresses is shown. If the phone had any existing values they are shown. Otherwise if the phone is new or has been [cleared](#)^[72], all the addresses are set to 0.0.0.0.
5. Set each address in turn by highlighting it and selecting **Change**. Enter the new address value and then select **Save**. To enter a . in IP addresses press *. The values that need to be set are:
 - **Phone =**
This is the phone's IP address. To accept the current value, press # or enter a value and then press #. If entering a new value, press the * key to enter a '.' character between digits.
 - **Call Server =**
This is the address of the H323 gatekeeper. For IP Office systems this is the IP address of the IP Office LAN.
 - **Router =**
This is the address of the phone's default IP gateway. For IP Office this is typically the IP address of the IP Office LAN. To accept the current value, press # or enter a value and then press #.
 - **Mask =**
This is the phone's IP Mask (also called the subnet mask). The mask is used with the IP address to indicate the phone's subnet. This should match the IP mask set for the IP Office Unit.
 - **HTTP File Server =**
This is the address of the HTTP file server from which the phone should request software and settings files.
 - **HTTPS File Server =**
This is the address of the HTTPS file server from which the phone should request software and settings files. The phone will attempt to use this address, if set, before using HTTP.
 - **802.1Q =**
To change the setting press *. Press # to accept the value.
 - **VLAN ID =**
For details of VLAN configuration, see [VLAN and IP Phones](#)^[59].
 - **VLAN Test =**
When using VLAN, this is the time in seconds the phone will wait from a response from the DHCP server in the VLAN before falling back to normal non-VLAN operation.
6. When all the values are set as required press **Back**.
7. Press **Exit**. The phone will restart using the new values.
8. The [phone registration](#)^[51] menu is displayed.

2.8 Phone Registration

For new phones and phones that have been [reset](#)^[71], the phone will request an extension number. If [auto-create](#)^[45] is enabled the extension number used, if free, will create new extension and user entries in the IP Office configuration. If auto-create is not enabled, the extension number used must match a VoIP extension entry within the IP Office configuration, see [Manually Creating Extensions](#)^[45].

1. Following file loading the phone will request extension information:

- **Ext. =**

Enter the extension number the phone should use and press #. **Wrong Set Type** is displayed if you try to use the extension number of an existing non-IP extension.

- **Password =**

The password used is as follows:

- If using auto-create for a new user and extension, just enter any number and press #. Any digits entered are not validated or stored.
- If not using auto-create, enter the user's **Login Code** as set in the IP Office configuration.

2. Test that you can make and receive calls at the extension.

2.9 Backup/Restore Settings

1600 and 9600 Series H323 IP Telephones support using an HTTP server as the location to which they can backup and restore user-specific data. The address for this backup server is set separately from that of the file server used for phone firmware.

These options are used if the location of the HTTP server for backup/restore has been specified in the phone **46xxsettings.txt** file.

- The address of the HTTP server for backup/restore operation is separate from the address of the HTTP server used for phone firmware files downloads.
- The HTTP server being used for backup/restore will require configuration changes to allow the phones to send files to it.
- If the IP Office system is being used as the file server for phone installation, it can also be used for the phone backup and restore functions. That includes [file auto-generation](#)^[22]. When using auto-generation, some settings within the restore file are based on the user's IP Office settings. This is therefore the recommended solution where possible.

Backup is used when the phone user logs out of the phone. During the log out process, the phone creates a file containing the user specific data and sends that to the BRURI location. The file is named with the user's extension number as a prefix to **_16xxdata.txt**; for example, **299_16xxdata.txt**.

Restore is used when a user logs in at the phone. The phone sends a file request for the appropriate file based on the user's extension number. If the file is successfully retrieved the phone will import the settings and, after a "Retrieval OK" message, continue as normal. If the file cannot be retrieved, a "Retrieval failed" message is displayed and the phone will continue with its existing settings.

Specifying the BRURI Value

If you are using the IP Office system as the file server it is recommended that you also use it as the backup and restore server. This option requires no additional configuration. If there is no **46xxsettings.txt** file on the IP Office system, it will auto-generate the file when it is requested by a phone and will include its own IP address as the backup/restore server address. If there is **46xxsettings.txt** file on the IP Office system, you can edit the backup/restore server address manually using the process below to set it to match the system's IP address.

If you want to use another server, edit the BRURI value in the **46xxsettings.txt** file. You will also need to ensure that the server being used is configured to allow the uploading of files to the specified folder on the server.

1. Open the **46xxsettings.txt** file.
2. Locate the line containing the **SET BRURI** value.
3. If the line is prefixed with **#** characters, remove those and any spaces.
4. After **SET BRURI**, enter a space and then the address of the HTTP backup server, for example **SET BRURI http://192.168.0.28**. If necessary, specify the path to a specific server directory and/or include a specific port number; for example: **SET BRURI http://192.168.0.28/backups:8080**.

HTTP Authentication

HTTP Authentication can be supported. If set it will be used for both the backup and the restore operations. The authentication credentials and realm are stored in the phone's programmable, non-volatile memory, which is not overwritten when new firmware is downloaded.

Both the authentication credentials and realm have a default value of null. If the HTTP server requires authentication, the user is prompted to enter new credentials using the phone. If the authentication is successful, the values used are stored and used for subsequent backup and restore operations.

Manual Backup/Restore Control

Users can request a backup or restore using the Advanced Options Backup/Restore feature as detailed in the user guide for the specific telephone model.

2.9.1 Example File

The following is an example of a backup/restore file for a 1600 Series phone user. Note that values are not written unless the setting has been changed from its default.

If the backup and restore is being done using [file auto-generation](#)^[22], those items indicated by ✓ are controlled by values stored and supplied by the user's IP Office settings.

File	Fields	Description
ABKNAME001=Extn201 ABKNUMBER001=201 ABKNAME002=Extn201ad ABKNUMBER002=201 ABKNAME003=Extn203 ABKNUMBER003=203 Redial=0 Call Timer=0 Visual Alerting=1 Call Log Active=1 Log Bridged Calls=1 Log Line Calls=1 Log Calls Answered by Others=0 Audio Path=2 Personalized Ring=7 Handset AGC=1 Headset AGC=1 Speaker AGC=1 Error Tone=1 Button Clicks=0 Display Language=English	ABKNAMEmmm ABKNUMBERmmm	These paired entries are used for personal contacts entered into the phone. The <i>mmm</i> value in each pair in replace by a 3-digit number starting with 001. The first line of the pair stores the contact name, the second line stores the phone number for the contact. ✓
	LANGUSER	Display language. The language name is stored. ✓
	LOGACTIVE	Call log active on (1) or off (0). ✓
	LOGBRIDGED	Log bridged calls on (1) or off (0). ✓
	LOGLINEAPPS	Log line calls on (1) or off (0). ✓
	LOGOTHERANS	Log calls answered by others on (1) or off (0). ✓
	OPTAGCHAND	Handset Automatic Gain Control on (1) or off (0).
	OPTAGCHEAD	Headset Automatic Gain Control on (1) or off (0).
	OPTAGCSPKR	Speaker Automatic Gain Control on (1) or off (0).
	OPTAUDIOPATH	Audio Path. ✓
	OPTCLICKS	Button Clicks on (1) or off (0). ✓
	OPTERRORTONE	Error Tone on (1) or off (0). ✓
	PERSONALRING	Personalized Ring. A numeric value (1 to 8) for the selected ring is stored. ✓
	PHNREDIAL	Redial
	PHNSCRONCALL	Go to call screen on calling on (1) or off (0).
	PHNSCRONALERT	Go to call screen on ringing on (1) or off (0).
	PHNTIMERS	Call Timer on (1) or off (0). ✓
	PHNVISUALALERT	Visual alerting on (1) or off (0). ✓

2.9.2 IIS Server Configuration

Create a backup folder under the root directory of your web server. All backup files will be stored in that directory. For example, if your backup folder is **C:/Inetpub/wwwroot/backup**, the **46xxsettings.txt** file should have a line similar to **SET BRURI http://www.website.com/backup/**.

1. Go to **Start | Settings | Control Panel | Administrative Tools** and select, depending on the Windows version, **Internet Information Services Manager** or **Internet Information Services**.
2. Right-click on the folder created for backup. Right-click on **Default Web Site** if there is no specific backup directory.
3. Select **Properties**.
4. In the **Directory** tab, make sure the **Write** box is checked.
5. Additional step for IIS 6.0:
 1. Go to **Start | Settings | Control Panel | Administrative Tools**.
 2. Below **Default Web Site**, select **Web Services Extension**.
 3. Ensure that the **WebDAV** option is set to **Allowed**.

2.9.3 Apache Server Configuration

Create a backup folder under the root directory of your Web server. Make the folder writable by everyone. All backup files will be stored in that directory. For example, if the backup folder is **C:/Program Files/Apache Group/Apache2/htdocs/backup**, the **46xxsettings.txt** file should have a line similar to **SET BRURI http://www.website.com/backup/**.

1. Edit your Web server configuration file **httpd.conf**.
2. Uncomment the two LoadModule lines associated with DAV:

```
LoadModule dav_module modules/mod_dav.so
LoadModule dav_fs_module modules/mod_dav_fs.so
```

- **Note:** If these modules are not available on your system (typically the case on some Unix/Linux Apache servers), you have to recompile these two modules (mod_dav & mod_dav_fs) into the server. Other ways to load these modules might be available. Check your Apache documentation at <http://httpd.apache.org/docs/> for more details.

3. Add the following lines in the **httpd.conf** file:

```
#
# WebDAV configuration
#
DavLockDB "C:/Program Files/Apache Group/Apache2/var/DAVLock"
<Location />
Dav On
</Location>
```

4. For Unix/Linux Web servers the fourth line might look more like: **DavLockDB/usr/local/apache2/var/DAVLock**
5. Create the **var** directory and make it writable by everyone. Right-click **Properties** and select **Security | Add | Everyone | Full Control**.

2.10 Listing Registered Phones

The IP Office System Monitor application can be used to check which phones are registered with the system.

1. Start IP Office System Monitor and connect to the IP Office system.
2. Select **Status | H323 Phone Status**.

The screenshot shows the IPPhoneStatus application window. At the top, it displays 'Total Configured: 5' and 'Total Registered: 2'. Below this is a 'Registered Status' progress bar. The main area is a table with the following columns: Extn Num, Phone Type, Licensed, IP Address, Mac, Version Id, EP identifier, Status, Registra..., TimeoutV..., TimeLast..., Avera..., RRQtime>1..., PhoneURQ, ErrorU..., and Exist... The table contains two rows of data:

Extn Num	Phone Type	Licensed	IP Address	Mac	Version Id	EP identifier	Status	Registra...	TimeoutV...	TimeLast...	Avera...	RRQtime>1...	PhoneURQ	ErrorU...	Exist...
1551	9621	1	192.168.0.222	00-1b...	6.1000	System_A_4df0c...	RAS: Regist...	3	240s	09/06/20...	56secs	0	0	2	0
299	1608	1	192.168.0.155	00-07...	1.2200	System_A_4dee...	RAS: Regist...	1	240s	07/06/20...	55secs	0	0	0	0

At the bottom of the window, there are 'Display Options' with radio buttons for 'Show All', 'Registered' (selected), and 'UnRegistered'. There are also buttons for 'Print', 'Reset Phones', and 'Cancel'.

IP Office System Monitor can also show how many phones have registered and how many are currently waiting to register. The **System | Print trace** filter option must be selected to see these messages. The following appears as lines of the form:

```
792ms PRN: GRQ from c0a82c15 --- RAS reaches the maximum capacity of 10; Endpoints registered 41
```

2.11 Other Installation Options

2.11.1 VPN Remote Phones

Avaya IP phones at remote locations can be connected to the IP Office system via IPSec VPN tunnels. This is supported for 4610SW, 4621SW, 5610SW and 5621SW phones. It is also supported for 9600 Series phones except the 9608, 9611, 9621, and 9641.

B5800 Branch Gateway systems do not support VPN remote phones.

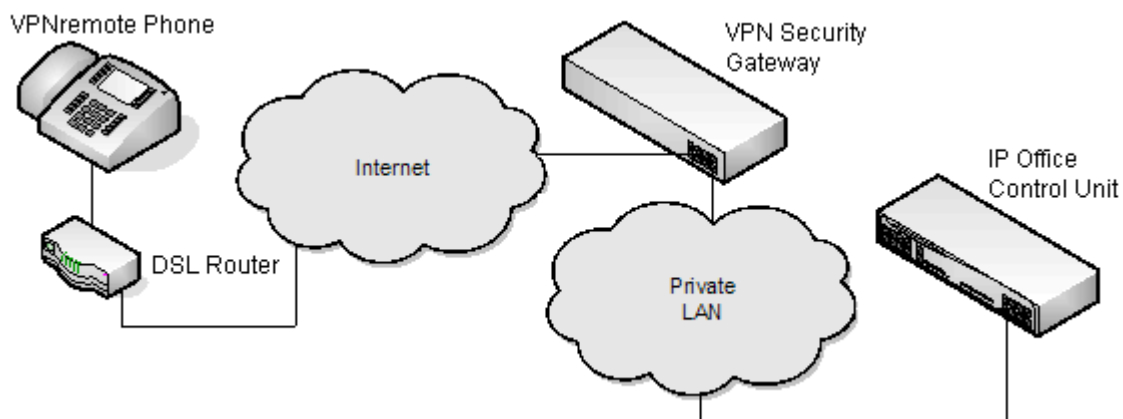

Additional components required for remote phones over VPN are:

1. IP Office VPNremote Phone Firmware

This firmware is included with the IP phone firmware set.

2. VPN Security Gateway

The IP Office system does not support all the IPSec features needed for VPNremote phones using its own IPSec tunnels. Therefore the VPN tunnel from remote phones must end at a suitable alternate VPN gateway device. The device must support one of the following methods:

- **Avaya Gateways**

Avaya security gateway devices (SG and VSU) use an Avaya proprietary protocol called CCD.

- **Non-Avaya Gateways**

Non-Avaya VPN gateways with IKE Extended Authentication (Xauth) with Pre-shared Key (PSK). Installation notes exist for the items listed below. This does not imply any recommendation of those devices by Avaya or preclude other devices.

Note: Avaya cannot guarantee support for services through non-Avaya devices.

Cisco VPN 300 Series Concentrators

Kentrox Q2300 VPN Router

Cisco PIX 500 Series Security Appliances

Sonicwall Tz170 VPN Router

Juniper Networks NetScreen Series VPN Devices

Netgear FVS338 VPN Router

Juniper Networks Secure Services Gateway 500 Series

Netgear FVX538 VPN Router

Juniper Networks Integrated Security Gateway (ISG) Series

Adtran Netvanta 3305 VPN Router

Installation Documentation

This document only covers notes and differences specific to installation of VPNremote phones with IP Office. The installation and configuration of Avaya VPNremote phones is covered in a number of existing documents available from the Avaya support website (<http://support.avaya.com>).

Product Section	Title	Doc Reference
VPNremote Phone	VPNremote for the 4600 Series IP Telephones Administrators Guide	19-600753
	VPNremote for 4600 Series IP Telephone User Installation and Configuration Quick Start - Self Installer	19-602363
IP Office	Technical Tip 184 - Configuring a VPNremote IP Phone with a Netgear FVS338 VPN Router	322690
	Technical Tip 185 - Configuring a VPNremote IP Phone with a Kentrox Q2300 VPN Router	322702
	Technical Tip 186 - Configuring a VPNremote IP Phone with an Adtran Netvanta 3305 VPN Router	322714
	Technical Tip 190 - Configuring a VPNremote IP Phone with a Sonicwall Tz170 VPN Router	325830
	Technical Tip 196 - Configuring a VPNremote IP Phone with a Netgear FVX538 VPN Router	327056

Supported VPNremote Phone Firmware

Unless otherwise advised, only the firmware provided on the IP Office Administrator Applications DVD should be used for VPNremote phones connected to an IP Office. That firmware is tested with the IP Office release represented by the DVD for correct operation. The firmware is located in a zip file in the folder `\bin\VPN Phone`.

Whilst other VPNremote firmware releases may be made available by Avaya for download, those firmware release may not have been specifically tested with IP Office.

Configuring the IP Phone for VPNremote

In addition, a **VPN Phone Allowed** checkbox option is present on the **Extension | VoIP** settings tab of IP extensions. This checkbox is used to indicate to the IP Office the extensions that are VPNremote and therefore require use of a license.

1. Using IP Office Manager, retrieve the current configuration from the IP Office system.
2. Click on  **Extension** and select the entry for the IP extension.
3. Select the **VoIP** tab.
4. Enable **VPN Phone Allowed**.
5. Click **OK**.
6. Repeat this for any other existing IP extensions that are going to be converted to VPN connection.
7. Save the configuration back to the IP Office system.

Configuring 4600 Series VPNremote Phones for IP Office Licensing

By default, 5600 Series phones running VPNremote firmware use licenses available from the IP Office to which they connect. However, 4600 Series phones running VPNremote can be licensed in a number of ways and so need to be instructed to use the IP Office for licensing.

In order to inform 4600 Series VPNremote phones to use IP Office licensing, the following line must be added to the **46vpnsettings.txt** file:

- SET SMBLIC 1

2.11.2 VLAN and IP Phones

The use of VLAN allows separate collision domains to be created on Ethernet switches. In the case of IP Office and IP Phones the advantages are:

1. It allows PCs to continue in the same IP subnet while IP Phones can use a new and separate IP addressing scheme.
2. Broadcast traffic is not propagated between the PC data network and the IP Phones voice network. This helps performance as otherwise broadcast traffic must be evaluated by all receivers.
3. VLAN networking and traffic prioritization at layer 2 are closely bound together in the same 802.2 standard. It is therefore easier to maintain L2 QoS when using a VLAN.

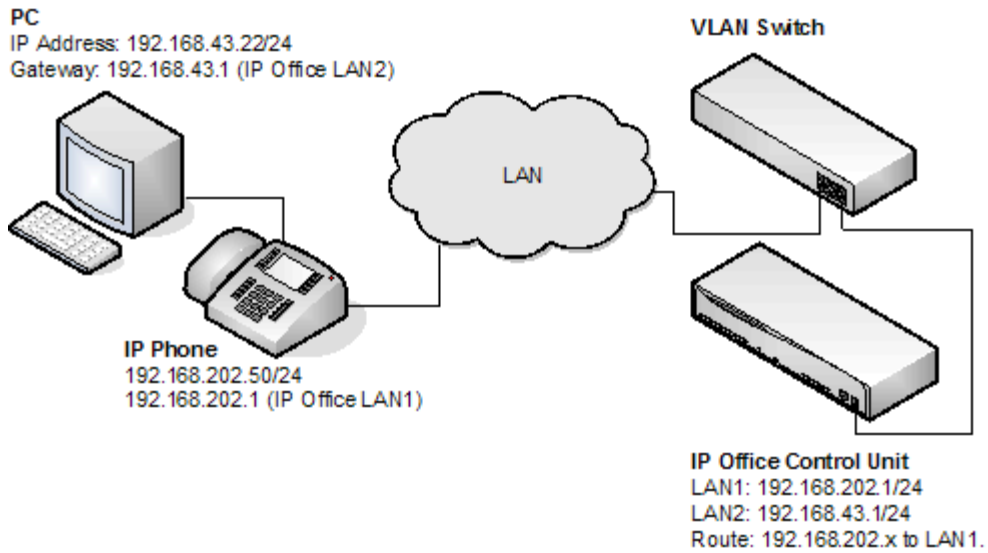

The table below shows the three ways in which VLAN can be deployed with an Ethernet Switch. The first two methods require only elementary configuration, and since this document assumes both PC and IP Phones share the same Ethernet port, the focus will be the third method (overlapping).

Type	Description	Advantages	Disadvantages
No VLAN	Both Voice and Data occupy the same collision domain	Simple configuration	PC broadcast traffic adverse effect on Voice traffic Requires two (2) ports per user; one for IP Phone and one for PC
Physical VLAN	Separate VLAN for data and voice	Simple configuration	Requires two (2) ports on switch; one for IP phone and one for PC
Overlapping VLAN	A single port on the switch carrying both the IP Phones as well as the PC traffic	Requires only a single port for both PC and IP Phone PC broadcast traffic cannot adversely effect Voice traffic	Complex configuration

VLAN and DHCP

The use of VLAN has implications on DHCP if DHCP is being used for support of IP phones and or PCs. The table below details the available options when using a single port for PC and IP Phones on a VLAN enabled network.

DHCP Option	Description
None (Static addressing)	Manual configuration of each IP Phone
Separate DHCP Servers	Two PCs, one for each VLAN
Multihomed DHCP Server	A single PC with two NIC Cards; one for each VLAN
DHCP Relay	The option must be supported by the Ethernet switch

If using DHCP, when the IP phone starts it first makes a DHCP request without a VLAN tag.

- If the DHCP reply contains a new VLAN setting as part of the SSON scope, the phones will release all its existing IP address and makes a new DHCP request using the newly supplied VLAN ID
- If the IP Phone does not get a new VLAN ID, it will continue with the settings provided in the original DHCP reply

A VLAN ID can also be passed to a phone through the **46xxsettings.txt** file that it loads. Again the IP phone will release all its existing IP parameters and then make a new DHCP request using the newly supplied VLAN ID.

In the example below, the when the IP phones receives a DHCP response from the DHCP server on the data VLAN, that response contains the VLAN ID of the voice VLAN. The phone then releases the original data VLAN settings it obtained and sends a new DHCP request to the voice VLAN.

Option	Data VLAN DHCP Settings	Voice VLAN DHCP Settings
IP Address	192.168.43.x	192.168.202.x
Mask	255.255.255.0	255.255.255.0
Router	192.168.43.1	192.168.202.1
SSON Scope	L2Q=1, L2QVLAN=202, VLANTEST=0	MCIPADD=192.168.202.1, MCPORT=1719, HTTPSRVR=192.168.202.X VLANTEST=0

The **VLANTEST** parameter is the length of time the IP Phone should make DHCP requests in a VLAN (0 means unlimited time).

Example setup - Overview

The network is devised to allow the user PC to connect to the switch port of the IP Phone. A single cable then connects PC and IP Phone to the Ethernet Switch. For the purpose of this example, VLAN 209 is used for voice traffic and VLAN 210 is used for data traffic. The LAN1 interface of the IP Office control unit resides on the voice VLAN while the LAN2 interface resides in the data VLAN. Communication between the voice and data VLANs is facilitated by the IP Office control unit's router function.

HP-Switch - Configuration

Shown below are the web and CLI configuration output from the HP Procurve Switch. These were obtained using the configuration guidelines found below.

AvayaLabs - Status: Non-Critical
HP J8164A ProCurve Switch 2626-PWR

Identity Status **Configuration** Security Diagnostics Support

Device View Fault Detection System Info IP Configuration
Port Configuration Monitor Port Device Features Stacking
VLAN Configuration Support/Mgmt URL

VLAN ID	VLAN Name	VLAN Type	Tagged Por	Untagged Ports	Forbid Ports	Auto	
1	Native (Prim:	STATIC	(STATIC) None	1-2,4, 7-26	None	3,5-6	Modify
			(GVRP) None				
209	Red [Voice]	STATIC	(STATIC) 3	5	None	1-2,4, 6-26	Modify
			(GVRP) None				
210	Blue [Data]	STATIC	(STATIC) None	3,6	None	1-2,4-5, 7-26	Modify
			(GVRP) None				

ADD/REMOVE VLANs GVRP Enabled GVRP Mode

HP Procurve CLI output

```
; J8164A Configuration Editor; Created on release #H.08.60

hostname "AvayaLabs"
snmp-server community "public" Unrestricted
vlan 1
name "Native"
untagged 1-2,4,7-26
ip address 192.168.202.201 255.255.255.0
no untagged 3,5-6
exit
vlan 209
name "Red [Voice]"
untagged 5
tagged 3
exit
vlan 210
name "Blue [Data]"
untagged 3,6
exit
gvrp
spanning-tree
```

The table below summarizes the HP configuration for ports and VLANs.

Port	VLAN 209 Voice	VLAN 210 Data	Description
3	Tagged	Untagged	This port was added to both VLAN 209 and VLAN 210. Note: When adding port 3 to VLAN 209 the Mode option must be tagged, but it must be untagged when adding to VLAN 210.
5	Untagged	-	This port is included only in VLAN 209 and not included in VLAN 210. The Mode option must be set to Untagged for port 5 in this VLAN.
6	-	Untagged	Port 6 is included only in VLAN 210 and not included in VLAN 209. The Mode option MUST be set to Untagged in this VLAN.

The operation of this network is dependant on the functionality defined in HP documentation. Specifically, HP refers to this type of VLAN operation as Overlapping VLAN. The configuration relies also on that fact that Avaya 4600 IP Phones support VLAN operation.

Example System Overview

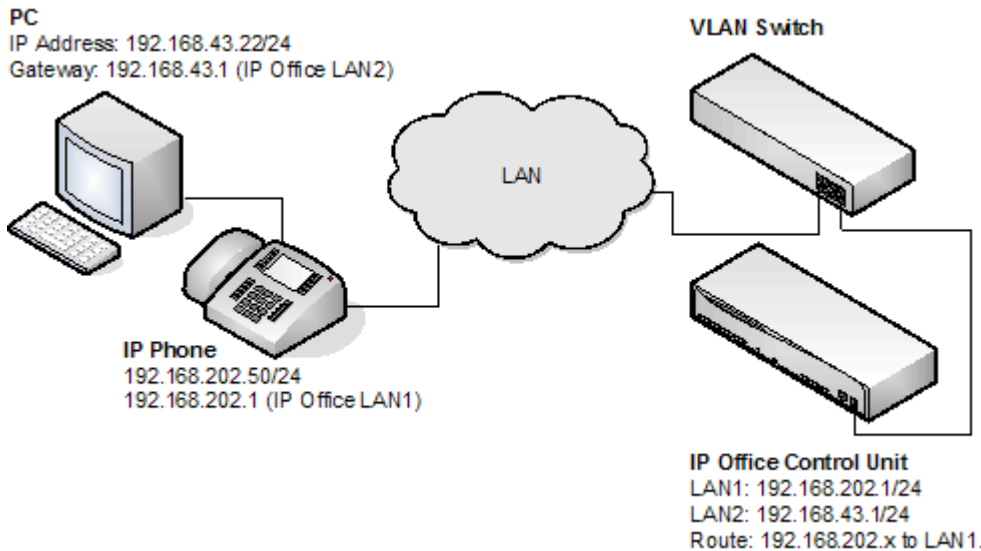

IP Office Configuration

The table below details the configuration for IP Office. Additional configuration is not required by IP Office in support of 802.1 tagging.

Option	Value
IP Address LAN1	192.168.202.1
IP Mask LAN1	255.255.255.0
IP Address LAN2	192.168.43.1
IP Mask LAN2	255.255.255.0
Router	192.168.202.1
Call Server	192.168.202.1

IP Phone- Configuration

In the example below, the IP phone was configured with fixed IP addressing.

Option	Value
IP Address	192.168.202.50
IP Mask	255.255.255.0
Router	192.168.202.1
Call Server	192.168.202.1
VLANID	209

VLAN Switch Configuration

The table below summarizes the HP configuration for ports and VLANs.

Port	VLAN 209 Voice	VLAN 210 Data
3	Tagged	Untagged
5	Untagged	-
6	-	Untagged

The PC –Configuration

Shown below is the IP configuration of the PC1; no option in support of 802.1p or 802.1q is enabled on the PC.

Option	Value
IP Address	192.168.43.22
IP Mask	255.255.255.0
Router	192.168.43.1

Summary

From the port on which the PC and IP phone reside, you can receive two types of Ethernet frame (i.e. sent from Phone or PC):

1. Tagged packets are sent by IP Phone.
2. Untagged packets are sent by PC.

When an untagged packet is sent by the PC attached to the IP Phone port, it will be propagated only to VLAN 210. This is because when we added the port 3 to VLAN 210 the **Mode** option was specified as untagged. While for the other VLAN (210) the option **Tagged** was selected for port 3 in VLAN 209. Tagged packets will thereby go to VLAN 209 while the untagged will go to 210.

When a packet originates from an IP Phone it is tagged. Since the option 'untagged' is selected for port 5 in VLAN 209, the 802.1 tag is removed before the switch forwards the packet to this port. Similarly, when an untagged packet is originated and sent by IPO the switch will tag the packet before forwarding LAN port 3.

Chapter 3.

Static Administration Options

3. Static Administration Options

A number of settings can be altered through the phone after installation. These procedures should only be used if you are using static address installation. Do not use these procedures if you are using DHCP except if you are attempting to reassign a phone that has been previously statically installed.



- To set parameters for all H323 IP phones on a system, you can edit the **46xxsettings.txt** script file. However, values assigned through static administration override any set through the **46xxsettings.txt** file. They remain active for the IP phone until a new boot file is downloaded.
- This section of documentation only includes a subset of the administration options. For a full list refer to the appropriate LAN administrator's manual:
 - [9600 Series IP Telephones Administrator Guide](#) (16-300698)
 - [4600 Series IP Telephone LAN Administrator Guide](#) (555-233-507)
 - [1600 Series IP Telephones Administrators Guide](#) (16-601443).

Using Static Administration Options

The method used to access static administration depends on the type of phone. Many of the static administration features are accessed using key sequences that begin by pressing either **MUTE** or **HOLD**. In recent firmware releases, preference has been given to using **MUTE** and some phones, for example the 1600 Series, will only support **MUTE**.

1600, 4600 and 5600 Series Phones

This section describes how to enter data for the administrative options.

1. All local procedures are started with the phone idle. Then dialling **MUTE** and then a sequence of up to seven (7) numbers followed by **#**.
2. After the **MUTE** button is pressed, a six (6) second timeout is in effect between button presses. If a valid button is not pressed within six (6) seconds of the previous button, the collected digits are discarded and no administrative options are started.
3. Attempts to enter invalid data are rejected and the phone emits an error beep.
4. If a numeric digit is entered for a value or for a field of an IP address or subnet mask after only a zero has been entered, the new digit will replace the zero.
5. To go to the next step, press **#**.
6. To backspace within a field depends upon the phone type:
 - **4601, 4602, 5601, 5602:**  Speaker key.
 - **4606:**  Conference key.
 - **4612 & 4624:**  Previous key.
 - **4610, 4620, 4625, 5610, 5620:** Left-most key.

9600 Series Phones

Administrative procedures for 9600 Series phones can only be accessed by restarting the phone.

1. While the phone is on-hook and idle, press the following sequence: **MUTE 2 7 2 3 8 # (MUTE C R A F T #)**.
2. Scroll the menu to the action required and select it.
3. When the selected procedure is finished, the phone will return to the procedures menu.
4. When all the required procedures have been completed, press **Exit**. The phone will restart using the new settings.

3.1 Secondary Ethernet (Hub)/IR Interface Enable/Disable

Use the following procedure to enable or disable the hub interface found on many Avaya IP phones which can be used for [user PC connection](#)^[18]. The hub interface is set to **enabled** by default.

For 4600 Series and 5600 Series phones, the procedure below can also be used to enable or disable the IR port found on some H323 IP phones; see [Infrared Dialling](#)^[80].

For 9600 Series phones, the procedure below also allows you to adjust the port speed and duplex setting of the PC port and the phone's LAN port.

1600, 4600 and 5600 Series Phones

1. While the phone is on-hook and idle, press the following sequence: **MUTE 4 6 8 # (MUTE I N T #)**. The phones port settings are shown in sequence. The options vary between different models of phone.

- **PHY2=**

This is the PC connection LAN socket marked as  on the phone. Press **1** or **0** to enable or disable the hub interface respectively. To continue, press **#**.

- **IR=**

This is the infrared (IR) port located on the front of some H323 IP phones. Press **1** or **0** to enable or disable the hub interface respectively. To continue, press **#**.

2. If you changed the setting, **Save new values?** is displayed. To end the procedure or save the new values, press **#**. If you press **#**, **New values being saved** is displayed and then the set returns to normal operation.

9600 Series Phones

1. While the phone is on-hook and idle, press the following sequence: **MUTE 2 7 2 3 8 # (MUTE C R A F T #)**.

2. Scroll the menu to **INT**.

3. Select the port that you want to adjust. The options are **Ethernet** and **PC Ethernet**.

4. Use the < and > buttons to scroll through the ports possible settings. The additional option **Disabled** is available for the PC Ethernet port.

5. Press **Save**.

6. Select another procedure or press **Exit** to restart the phone.

3.2 View Details

You can use the following procedure to view a number of phone details. These are in addition to the other static address and local administration options which can also be used to review settings.

1600, 4600 and 5600 Series Phones

1. While the phone is on-hook and idle, press the following sequence: **MUTE 8 4 3 9 # (MUTE V I E W #)**.

- To display the details, press ***** at any time during viewing.
- To end the procedure and restore the user interface to its previous state, press **#**.

2. A sequence of values are displayed. The values available vary between phone models and the level of IP phone software installed on the phone. To display the next value press *****. To exit the information display press **#**.

- **Model** - Shows the phone's model number; for example, 4624D02A.
- **Market** - Shows **1** for export or **0** for domestic (US). Not displayed on all phone types.
- **Phone SN** - Shows the phone's Serial Number.
- **PWB SN** - Shows the phone's Printed Wiring Board Serial Number.
- **PWB comcode** - Shows the PWB's comcode.
- **MAC address** - Shows the phone's MAC address as paired hexadecimal numbers.
- **L2 tagging** - Indicates whether L2 tagging is **on**, **off** or set to **auto**.
- **VLAN ID** - The VLAN ID used for the phone. The default is **0**.
- **IP address** - The IP address assigned to the phone.
- **Subnet mask** - The subnet mask assigned to the phone.
- **Router** - The router address assigned to the phone.
- **File server** - The address of the file server assigned to the phone.
- **Call server** - The address of the phone's H323 Gatekeeper.
- **802.1X** - The current setting for 802.1X operation if being used.
- **Group** - This displays the group value set on the phone. Group values can be used to control which options (both firmware and settings) a phone downloads. Refer to the 4600 Series Phone LAN Administrator Guide.
- **Protocol** - Display **Default**.
- **filename1** - Shows the name of the phone application file in the phone's memory. These are values from within the boot file loaded and not the actual file name.
- **10Mbps Ethernet** or **100Mbps Ethernet** - Shows the speed of the detected LAN connection.
- **filename2** - Shows the boot file name and level. These are values from within the boot file loaded and not the actual file name.

9600 Series Phones

1. While the phone is on-hook and idle, press the following sequence: **MUTE 2 7 2 3 8 # (MUTE C R A F T #)**.

2. Scroll the menu to **VIEW** and start the procedure.

- **Model** - Shows the phone's model number; for example, 4624D02A.
- **Phone SN** - Shows the phone's Serial Number.
- **PWB SN** - Shows the phone's Printed Wiring Board Serial Number.
- **PWB comcode** - Shows the PWB's comcode.
- **MAC** - Shows the phone's MAC address as paired hexadecimal numbers.
- **Group** - This displays the group value set on the phone. Group values can be used to control which options (both firmware and settings) a phone downloads. Refer to the 4600 Series Phone LAN Administrator Guide.
- **Protocol** - Display **Default**.
- **Application File** - Shows the name of the phone application file in the phone's memory. These are values from within the boot file loaded and not the actual file name.
- **Ethernet** - Shows the speed of the detected LAN connection.
- **Boot File** - Shows the boot file name and level. These are values from within the boot file loaded and not the actual file name.
- **Proxy Server** - Shows the details of the selected proxy server.
- **Voice Language File** - The name of the language file the phone is using. This is blank when using the phone's default language (English).

3. Press **Back**.

4. Select another procedure or press **Exit** to restart the phone.

3.3 Self-Test Procedure

1600, 4600 and 5600 Series Phones

1. To start the IP phone self-test procedure, press the following sequence: **MUTE 8 3 7 8 # (MUTE T E S T #)**. The phone does the following:

- Each column of programmable button LEDs is lit for half a second from left to right across the phone, in a repeating cycle. The Speaker/Mute LED and the message waiting LED are also lit in sequence.
- Buttons (other than #) generate a click if pressed.
- Phones with displays show **Self test #=end** for one (1) second after self-test is started. Then a block character (all pixels on) is displayed in all display character locations for five (5) seconds. Display of the block character is used to find bad display pixels.

2. One of the following is finally displayed:

- **If self-test passes:**

```
Self test passed  
#=end
```

- **If self-test fails:**

```
Self test failed  
#=end
```

3. To end the self-test, press #. The phone returns to normal operation.

9600 Series Phones

1. While the phone is on-hook and idle, press the following sequence: **MUTE 2 7 2 3 8 # (MUTE C R A F T #)**.

2. Scroll the menu to **Test**.

3. Press **Test** again to confirm the action.

3.4 Resetting a Phone

Resetting a phone resets all the system values and most of the system initialization values. The procedure does not affect user-specified data and settings (e.g. Contact data, Options settings, login extension or password, etc.). To remove all such data, refer to [Clearing a Phone](#)^[72].

1600, 4600 and 5600 Series Phones

1. While the phone is on-hook and idle, press the following sequence: **MUTE 7 3 7 3 8 # (MUTE R E S E T #)**. **Reset values?** is displayed.
2. To cancel this procedure press *. To continue press #.
 - **WARNING**
As soon as you press #, all static information will be erased without any possibility of recovering the data.
3. Whilst the system values are reset to their defaults, **Resetting values** is displayed.
4. Once the system values are reset, **Restart phone?** is displayed.
 - To end the procedure without restarting the phone, press *.
 - To restart the phone, press #. The remainder of the procedure then depends on the status of the boot and application files. See [Restart Scenarios](#)^[76].

9600 Series Phones

1. Restart the phone or remove and then reapply power.
2. When the option **Press * to program** is displayed, press the * key.
3. When **Enter code** is displayed, enter the administrative procedures passcode and press #. The default passcode is **CRAFT (2 7 2 3 8)**.
4. Scroll to the desired menu and select it.
5. Scroll the menu to **Reset Values**.
6. Press **Reset** to confirm the action. The phone user settings are cleared and the phone restarted.

3.5 Clearing a Phone

Clearing all system initialization values back to their default settings and deleting all user-specific data is intended primarily for repair and for use when the phone is given to a new user. This returns the phone near to its original, out-of-box state. The phone will yet retain the firmware files it has already downloaded.

Note: Some parameters, such as button clicks, error tones, and personalized ringing, may be set for a specific user via the **A MENU**. These user settings will be restored when you register the user to the phone because those parameters are configured in IP Office. All other settings (e.g. Contact data, Options settings, etc.) will be cleared from the phone.

1600, 4600 and 5600 Series Phones

1. While the phone is on-hook and idle, press the following sequence: **MUTE 2 5 3 2 7 # (MUTE C L E A R #)**. **Clear all values?** is displayed.

2. To cancel this procedure press *. To continue press #.

- **WARNING**

As soon as you press #, all static information will be erased without any possibility of recovering the data.

3. Whilst the system values are reset to their defaults, **Clearing values** is displayed.

4. Once all values are cleared, the phone will restart as if it is a new phone.

9600 Series Phones

1. Restart the phone or remove and then reapply power.

2. When the option **Press * to program** is displayed, press the * key.

3. When **Enter code** is displayed, enter the administrative procedures passcode and press #. The default passcode is **CRAFT (2 7 2 3 8)**.

4. Scroll to the desired menu and select it.

5. Scroll the menu to **Clear**.

6. Press **Clear** again to confirm the action. The phone settings are cleared and the phone restarted.

3.6 Site Specific Option Number

The Site Specific Option Number (SSON) is used by IP phones to request information from a DHCP server that is specific to the phones and not to other IP devices being supported by the DHCP server. The number must match a similarly-numbered 'option' set on the DHCP server that defines the various settings required by the phone.

The default SSON used by Avaya 4600 and 5600 Series phones is **176**. The default SSON used by Avaya 1600 Series and 9600 Series phones is **242**. For phones being supported by IP Office DHCP, the SSON used by the phone must match one of the site specific option numbers set in the [IP Office configuration](#)³⁶.

- **! WARNING**

Do not perform this if using static addressing. Only perform this procedure if using DHCP addressing and the DHCP option number has been changed from the normal default.

1600, 4600 and 5600 Series Phones

1. While the phone is on-hook and idle, press the following sequence: **Mute 7 7 6 6 # (Mute S S O N #)**. **SSON=** is displayed followed by the current value.
2. Enter the new setting. This must be a number between **128** and **255**.
3. To cancel this procedure, press ***** or press **#** to save the new value.

9600 Series Phones

1. While the phone is on-hook and idle, press the following sequence: **MUTE 2 7 2 3 8 # (MUTE C R A F T #)**.
2. Scroll the menu to **SSON** and start the procedure.
3. Enter the new SSON number that the phone should use when it next restarts.
4. Press **Save**.
5. Select another procedure or press **Exit** to restart the phone.





Chapter 4.

Restart Scenarios

4. Restart Scenarios

The sequence of the restart process depends on the version of the phone boot file already downloaded to the phone as well as those on the file server. This appendix explains the different scenarios possible.

All of the following start-up procedures involve the same initial steps as the phone negotiates with the DHCP server and the file server.

1. After power is applied, the phone displays **Restarting...** followed by **Initializing...**
2. When either the application file (if there is one) or the boot code is uncompressed into RAM, **Loading** is displayed. Since this takes a while, asterisks, then periods, then asterisks are displayed on the second line to indicate that something is happening.
3. When control is passed to the code in RAM, **Starting** is displayed.
4. The phone detects and displays the speed of the Ethernet interface in Mbps (that is 10 or 100). The message No Ethernet means the LAN interface speed cannot be determined. The Ethernet speed indicated is the LAN interface speed for both the phone and any attached PC.
5. DHCP is displayed whilst the phone obtains an IP address and other information from the LAN's DHCP server. The number of elapsed seconds is incremented until DHCP successfully completes.
 - If the phone has been setup using static addressing (by pressing * when DHCP is shown), it will skip DHCP and use the static address settings it was given.
 - Note that uploading a new boot file at any time erases all static address information.
6. Once DHCP has completed successfully, the phone will request files from the file server indicated in the DHCP response. The first file requested details the other files that the phone should also load. The phone will first make its file request using HTTPS. If this fails it will make the same request using HTTP. If that fails it will make a final request using TFTP. If all requests for a file fail, the phone will fallback to using the current version of the file it has in its own memory.
7. After the upgrade script is loaded, the sequence depends on the status of the files currently held in the phone's memory, compared to those listed in the upgrade script file.
 - [Boot File Needs Upgrading](#) 
 - [No Application File or Application File Needs Upgrading](#) 
 - [Correct Boot File and Application File Already Loaded](#) 

4.1 Boot File Needs Upgrading

Having processed the upgrade script file, the software determines that the name of the boot code file in the phone does not match that in the upgrade script. The script specifies the name of the new file to load.

1. The phone displays the file name and the number of kilobytes loaded.
2. The phone displays **Saving to flash** while the new boot file is stored in its flash memory. The percentage of the file stored and the number of seconds that have elapsed are shown. This will usually take longer than it took to download the file.
3. The phone displays **Restarting** as it prepares to reboot using the new boot file.
4. The phone displays **Initializing**.
5. While the new boot file is uncompressed into RAM, the phone displays **Loading**. Since this takes a while, asterisks, then periods, then asterisks are displayed on the second line to indicate that something is happening.
6. When control is passed to the software that has just loaded, the phone displays **Starting**.
7. The phone displays **Clearing** whilst the flash memory is erased in preparation for rewriting the code. The percentage of memory erased and number of elapsed seconds are also shown.
8. Updating is displayed whilst the boot code is rewritten. The phone also displays the percentage of boot code rewritten and the number of elapsed seconds.
9. When the new boot code has been successfully written into the flash memory, the phone resets so that the status of the phone application files can be checked.

Continue with the next procedure: [No Application File or Application File Needs Upgrading](#) .

4.2 No Application File or Application File Needs Upgrading

This happens with normal application file upgrades. Having processed the upgrade script file, the software determines that the name of the boot file in the phone is the correct version. It next determines that the name of the application file does not match that stored in the phone.

1. The phone displays the required file name as it downloads the file from the TFTP server. It also displays the number of kilobytes downloaded.
2. **Saving to flash** is displayed. The phone also displays the percentage of file stored and the number of seconds that have elapsed. This will usually take longer than it took to download the file.
3. The phone is reset so that the new system-specific application file can be executed.

Continue with the next procedure: [Correct Boot File and Application File Already Loaded](#) .

4.3 Correct Boot File and Application File Already Loaded

This happens with most normal restarts. Having processed the upgrade script file, the software determines that the name of the boot file in the phone and the phone application file match those specified in the upgrade script.

1. System-specific registration with the switch is started. The phone requests the extension number it should use and the password.
 - By default, the phone displays the last extension number it used. To accept, press #.
 - Whilst a password request is shown, password verification is not performed except if the user changes the extension number.
 - The password is checked against is the user's Login Code stored in IP Office Manager.
2. Upon completion of registration, a dial-tone is available on the phone if it has also been able to obtain an **Avaya IP Endpoint** license.

Chapter 5.

Infrared Dialing

5. Infrared Dialing

Some H323 IP phones include an infrared (IR) port at the front of the phone. This includes the 4606, 4612, 4624 and 4620 phone. The port appears as a dark plastic window on the front edge of the phone, just below the normal dialling keys.



You can use the IR port in the following ways:

- **Dial a Number to Start a Call**
This can be done by beaming the contact information held in a personal organizer address book.
- **Swap Text Files During a Call**
If calling another IP phone extension that has an IR port, text files can be beamed between extensions.

When using infrared beaming, the following must be remembered:

- The device beaming or receiving must be IrDA-compatible. This is the case for most computer and personal organizer IR ports.
- The range of transmission is typically a maximum of five (5) feet (or 1.5 meters) with a 5° degree spread (this is unlike IR devices used for remote controls which typically beam over a longer range and have a wider angle spread).
- For details of enabling and using IR beaming from your personal organizer or PC, refer to the manufacturer's information.

Notes:

- Some personal organizers can be set to beam to modems and mobile phones which use different transmission formats. The personal organizer may need to be set to beaming to another PC/personal organizer for dialling to work.
- These features have been tested with several devices as indicated. However, this is not a commitment to continually test or support those devices against future levels of software.

5.1 Enabling the IR Port

By default, where fitted, the IR port on H323 IP phones is enabled. If necessary, it can be disabled.

1. With the phone on-hook and idle, press **MUTE 4 6 8 # (MUTE I N T #)**. **PHY2=** and the current status is displayed. This is the setting for the phone's pass-through Ethernet port.
2. To continue, press **#. IR=**. The current status is displayed.
3. Change the status if required by following the displayed prompts and then press **#**. The phone will restart.

5.2 Dialing Phone Numbers

You can use the IR port to receive phone numbers beamed from an IR-enabled PC or pocket organizer device. Any device that can beam contacts in the VCard format (.vcf) can be used.

If you are unsure of the file format used by your IR device, you can try beaming a contact anyway. The display on the IP phone will show the name of the file it received. If that ends in .vcf, then the phone should dial the number in the VCard file.

You will need to remember the following:

- The phone will only dial the first phone number in the VCard file.
- If your IP Office system has been setup to need a prefix for external dialling, that prefix must be in the VCard phone number.

In addition to dialling the phone number digits, the following additional characters can be included in the phone number:

- **m** = Mute
- **c** = Conference
- **h** = Hold
- **t** = Transfer
- **,** (comma) = 2-second pause

The following sections contains examples of dialling contacts by beaming from various different devices.

Palm Organizer

The following was tested using a Palm Vx and M505. The connection setting (**Prefs | Connection**) must be **Ir to PC/Handheld**.

1. To enter the address book, click on the phone button or icon.
2. Locate the person or organization that you want to dial.
3. To go to **Address View**, click on the entry.
4. On the letters area of the graffiti pad, make a sweep from the bottom-left to the top-right. A set of icons should appear. Click on the beam icon. Alternatively, click on the menu icon and select Beam Address.

Windows Pocket PC

The following was tested using a Compaq iPAQ Pocket PC:

1. In **Contacts**, select the entry you want to dial.
2. Click **Tools** and then select **Beam Contact**. The Pocket PC will search for and then display the IR-enabled devices found. The IP phone should appear on the list.
3. Select the IP phone and the contact information will be beamed to it.

5.3 Beaming Files During a Call

During a call between two IR-enabled extensions on the same system, you can also beam files between IR devices at each end.

The types of file sendable and receivable will depend on those supported by the devices sending and receiving, as if they were face-to-face.

VCard files can be exchanged without being interpreted as a number to dial.

Palm Organizer

The following was tested using a Palm Vx and M505.

1. Inform the caller that you want to beam them a file and to have their Palm positioned in front of their extension's IR port ready to receive.
2. Locate the file that you want to send.
3. On the letters area of the graffiti pad, make a sweep from the bottom-left to the top-right. A set of icons should appear. Click on the beam icon. Alternatively, click on the **Menu** icon and select the displayed **Beam** option. The phones should display the first eight characters and the file extension of the file being transferred.

Chapter 6.

Alternate DHCP Server Setup

6. Alternate DHCP Server Setup

The recommended installation method for H323 IP phones uses a DHCP server. This section outlines by example, the basic steps for using a Windows server as the DHCP server for IP phone installation. The principles of defining a scope are applicable to most DHCP servers.

You will need the following information from the customer's network manager:

- The IP address range and subnet mask the H323 IP phones should use
- The IP Gateway address
- The DNS domain name, DNS server address and the WINS server address
- The DHCP lease time
- The IP address of the IP Office unit
- The IP address of the PC running Manager (this PC acts as a file server for the H323 IP phones during installation)

6.1 Alternate Options

In this document, all IP phone information is issued through the Scope and the Option 176 settings. Depending on the DHCP server, other options may have to be used within the scope.

- **Option 1 - Subnet mask**

- **Option 3 - Gateway IP Address**

If using more than one address, the total list can contain up to 255 total ASCII characters. You must separate IP addresses with commas with no intervening spaces.

- **Option 6 - DNS server(s) Address**

If using more than one address, the total list can contain up to 127 total ASCII characters. You must separate IP addresses with commas with no intervening spaces. At least one address in Option 6 must be a valid, non-zero, dotted decimal address.

- **Option 15 - DNS Domain Name**

This string contains the domain name to be used when DNS names in system parameters are resolved into IP addresses. This domain name is appended to the DNS name before the IP telephone attempts to resolve the DNS address. Option 15 is necessary if you want to use a DNS name for the HTTP server.

- **Option 51 - DHCP Lease Time**

If this option is not received, the DHCP offer is not accepted. Avaya recommends a lease time of six (6) weeks or greater. If this option has a value of FFFFFFFF hex, the IP address lease is assumed to be infinite as per RFC 2131, Section 3.3, so that renewal and rebinding procedures are not necessary even if Options 58 and 59 are received. Expired leases cause Avaya IP Telephones to reboot.

- Avaya recommends providing enough leases so that an IP address for an IP telephone does not change if it is briefly taken offline.
- DHCP standard states that when a DHCP lease expires, the device should immediately cease using its assigned IP address. If the network has problems and the only DHCP server is centralized, the server is not accessible to the given telephone. In this case the telephone is not usable until the server can be reached.
- Avaya recommends, once assigned an IP address, the telephone continues using that address after the DHCP lease expires, until a conflict with another device is detected. The 1600 Series IP Telephone customizable parameter DHCPSTD allows an administrator to specify that the telephone either:
 - comply with the DHCP standard by setting DHCPSTD to 1
or
 - continue to use its IP address after the DHCP lease expires by setting DHCPSTD to 0. This is the default. If used, after the DHCP lease expires, the telephone sends an ARP Request for its own IP address every five (5) seconds. The request continues either forever, or until the telephone receives an ARP Reply. After receiving an ARP Reply, the telephone displays an error message, sets its IP address to 0.0.0.0, and attempts to contact the DHCP server again.

- **Option 52 - Overload Option**

If this option is received in a message, the telephone interprets the name and file fields in accordance with IETF RFC 2132, Section 9.3, listed in Appendix B: Related Documentation.

- **Option 53 - DHCP Message Type**

Value is 1 (DHCPDISCOVER) or 3 (DHCPREQUEST).

- **Option 55 - Parameter Request List**

Acceptable values are: 1 (subnet mask), 3 (router IP address[es]), 6 (domain name server IP address[es]), 15 (domain name), NVSSON (site-specific option number)

- **Option 57 - Maximum DHCP Message Size**

- **Option 58 - DHCP Lease Renew Time**

If not received or if this value is greater than that for Option 51, the default value of T1 (renewal timer) is used as per IETF RFC 2131, Section 4.5.

- **Option 59 - DHCP Lease Rebind Time**

If not received or if this value is greater than that for Option 51, the default value of T2 (rebinding timer) is used as per IETF RFC 2131, Section 4.5

Note: On H323 IP phones, any Option 66 settings will be overridden by any TFTP entry in Option 176. Using Option 66 as part of the Scope is useful if alternate Gatekeeper addresses are required in the Option 176 settings whilst keeping within the 127 character limit.

6.2 Checking for DHCP Server Support

1. On the server, select **Start | Program | Administrative Tools | Computer Management**.
 2. Under **Services and Applications** in the Computer Management Tree, locate **DHCP**.
 3. If DHCP is not present then you need to install the DHCP components. Refer to the Microsoft documentation.
- If the DHCP server role is supported, the first stage is to [create a scope](#)^[86] of addresses for use by IP phones.

6.3 Creating a Scope

A DHCP scope defines the IP addresses that the DHCP server can issue in response to DHCP requests. Different scopes may be defined for different types of devices.

1. Select **Start | Programs | Administrative Tools | DHCP**.
2. Right-click on the server and select **New | Scope**.
3. The scope creation wizard will be started, click **Next**.
4. Enter a name and comment for the scope and click **Next**.
5. Enter the address range to use, for example, from 200.200.200.1 to 200.200.200.15 (remember the host part cannot be 0).
6. Enter the subnet mask as either the number of bits used or the actual mask, for example, 24 is the same as 255.255.255.0 and click **Next**.
7. You can specify addresses to be excluded. You can do this either by entering a range (e.g. 200.200.200.5 to 200.200.200.7) and clicking **Add**, or by entering a single address and clicking **Add**.
Note: You should exclude the IP Office from this range, as the DHCP Options in the IP Office should be disabled. This is only a recommendation. You can also accomplish this by leaving available addresses outside of the scopes range.
8. Click **Next**.
9. You can now set the lease time for addresses. If set too large, addresses used by devices no longer attached will not expire and be available for reuse in a reasonable time. This reduces the number of addresses available for new devices. If set too short, it will generate unnecessary traffic for address renewals. The default is 8 days. Click **Next**.
10. The wizard gives the option to configure the most common DHCP options. Select **Yes** and then click **Next**.
11. Enter the address of the gateway and click **Add**. You can enter several addresses. When all are entered, click **Next**.
12. Enter the DNS domain (eg. example.com) and the DNS server addresses. Click **Next**.
13. Enter the WINS server addresses and click **Add** and then click **Next**.
14. You will then be asked if you wish to activate the scope. Select **No** and then click **Next**.
15. Click **Finish**. The new scope will now be listed and the status is set to **Inactive**.

Having created the scope that will be used by the IP phones, [a set of options](#)^[86] need to be added matching the Site Specific Options Number (SSON) that the phones will use. The SSON used by 1600 and 9600 Series phones by default is 242.

6.4 Adding a 242 Option

In addition to issuing IP address information, DHCP servers can issue other information in response to requests for different specific DHCP option numbers. The settings for each option are attached to the scope. 1600 and 9600 Series H323 IP phones use SSON 242 to request additional information from a DHCP server. The option should include defining the address of the phone's H323 gatekeeper (the IP Office) and the address of the HTTP file server.

1. Right-click on the DHCP server.
2. From the pop-up menu, select **Predefined options**.
3. Select **Add**.
4. Enter the following information:
 - **Name:** 16xxOptions
 - **Data type:** String
 - **Code:** 242
 - **Description:** IP Phone settings

5. Click **OK**.

6. In the string value field, enter the following:

```
MCIPADD=xxx.xxx.xxx.xxx,MCPORT=1719,HTTPSRVR=yyy.yyy.yyy.yyy,HTTPDIR=z, VLANTEST=0
```

where:

- **MCIPADD=** the H323 Gatekeeper (Callserver) address. Normally, this is the IP Office Unit's LAN1 address. You can enter several IP addresses, separating each by a comma with no space. This allows specification of a fallback H323 gatekeeper.
Note: The phones will wait three (3) minutes before switching to the fallback and will not switch back when the first server recovers, until the phone is rebooted.
- **MCPORT=** the RAS port address for initiating phone registration. The default is 1719.
- **HTTPSRVR=** the HTTP file server IP address.
- **HTTPDIR=** the HTTP file directory where the IP phone files are located. This entry is not required if those files are in the server's root directory.
- The maximum string length is 127 characters. To reduce the length, the TFTP Server address can be specified through attaching an Option 66 entry to the Scope. See [Alternate Options](#)^[85].

7. Click **OK**.

8. Expand the server by clicking on the **[+]** next to it.

9. Click on the scope you just created for the 1600 and 9600 phones.

10. In the right-hand panel, right-click on the scope and select **Scope Options**.

11. In the general tab, make sure **242** is checked.

12. Verify the String value is correct and click **OK**.

Having created a 242 option and associated with the scope we want used by the IP phones, we now need to [activate the scope](#)^[89].

6.5 Adding a 176 Option

4600 and 5600 Series H323 IP phones use SSON 176 to request additional information from a DHCP server. The option 176 scope can be set up to use the same HTTP file server as shown for 1600 Series phones in the [previous example](#)^[86]. However, some older 4600 Series H323 IP phones only support TFTP so the options for a TFTP scope are shown below.

1. Right-click on the DHCP server.

2. From the pop-up menu, select **Predefined options**.

3. Select **Add**.

4. Enter the following information:

- **Name:** 46xxOptions
- **Data type:** String
- **Code:** 176
- **Description:** IP Phone settings

5. Click **OK**.

6. In the string value field, enter the following:

```
MCIPADD=xxx.xxx.xxx.xxx,MCPORT=1719,TFTPSRVR=yyy.yyy.yyy.yyy,TFTPDIR=z, VLANTEST=0
```

where:

- **MCIPADD=** the H323 Gatekeeper (Callserver) address. Normally, this is the IP Office Unit's LAN1 address. You can enter several IP addresses, separating each by a comma with no space. This allows specification of a fallback H323 gatekeeper.
Note: The phones will wait three (3) minutes before switching to the fallback and will not switch back when the first server recovers, until the phone is rebooted.
- **MCPORT=** is the RAS port address for initiating phone registration.
- **TFTPSRVR=** is the TFTP Server IP Address. Normally, this is the IP address of the PC running Manager.
- **TFTPDIR=** is the TFTP Server directory where the IP phone files are located. This entry is not required if those files are in the TFTP server's default directory.

7. The maximum string length is 127 characters. To reduce the length, the TFTP Server address can be specified through attaching an Option 66 entry to the Scope. See [Alternate Options](#)^[85].

8. Click **OK**.

9. Expand the server by clicking on the **[+]** next to it.

10. Click on the scope you just created for the 4600 phones.

11. In the right-hand panel, right-click on the scope and select **Scope Options**.

12. In the general tab, make sure **176** is checked.

13. Verify the String value is correct and click **OK**.

6.6 Activating the Scope

The scope can be manually activated by right-clicking on the scope, select **All Tasks** and select **Activate**. The activation is immediate.

You should now be able to start installing H323 IP phones using DHCP. If Manager is being used as the HTTP or TFTP server, ensure that it is running on the specified PC.

Chapter 7.

WML Server Setup

7. WML Server Setup

The 4610SW, 4620, 4620SW, 5610SW, 5620 and 5620 phones can act as WAP (Wireless Access Protocol) browsers. This allows them to view WML (Wireless Markup Language) pages. WML is a page coding language similar to HTML but intended for phone devices with small screens and no full keyboard.

To do WAP browsing, the phones need to be configured to access a home page. That home page can contain links and information appropriate to the customer installation.

This section looks at the setting up and configuration of a simple test system. The aim is to introduce the basic principles of WAP browsing operation.

- For testing and demonstration purposes, Avaya hosts a set of WML files at <http://support.avaya.com/elmodocs/avayaip/4620/home.wml>.
- Most PC web browsers cannot display .wml files. However, Opera is able to display WML pages which makes it a useful tool with which to test WML access and operation.

What WML is Supported

The phones are WML 1.2-compliant WAP browsers. However, they do not support all WML 1.2 tags.

For details of the supported WML 1.2 tags, refer to the 4600 Series IP Telephone LAN Administrator's Guide.

WTAI (Wireless Telephony Application Interface) links are supported to allow numbers embedded in WML pages to be dialed from phones.

7.1 Testing 4620 WML Browsing Using Xitami



1. Introduction

Xitami is a small and simple web server application. It is used here to configure one of our LAN PCs as a web server able to provide .wml pages in response to requests from an IP phone.

- **Web Server PC**
Any Windows PC on the IP Office LAN. Ideally, this PC should have a fixed IP address.
- **Server Software**
Xitami can be obtained from <http://www.imatix.com>. A copy is available on the IP Office Documentation CD. If an alternate Apache or IIS web server is available, refer to the section on configuring [Apache](#)^[96] or [IIS](#)^[96] for WML files.
- **Sample WML Pages**
A number of sample pages can be downloaded at <http://support.avaya.com/japple/css/japple?PAGE=ProductArea&temp.productID=107755>.

2. Installing the Web Server

For this test we used a web server called Xitami. It is a simple, small and flexible web server for use on Windows based PCs.

1. On the server PC, run **Xitami.exe** to start installation of the web server.
2. Accept the various defaults.
3. When asked for a **User Name** and **Password**, note the details entered.
4. When finished, select **Run**. The Xitami server appears as an  icon.
5. To display the web servers basic properties, double-click . Note the IP addresses.
6. To close the window without stopping the web server, click **Close**.
7. Open the PC's web browser and enter **http://<server IP address>**. You should see the default Xitami web pages.

If there are other PCs on the IP Office LAN they should also be able to browse the web server's IP address.

3. Configuring the Xitami Web Server for WAP

Basic web browsing consist of requests to the web server for .htm and .html text pages and .gif and .jpg images which are then displayed by a browser program. WAP browsing uses different file types, .wml for text and .wbmp for images.

The web server needs to be configured to recognize those file types, and several others, as files that might be requested by a WAP browser program. This is done by adding what many web servers refer to as MIME types.

1. On the web server PC, open the folder **C:\Xitami**.
2. Using a plain text editor such as Notepad or WordPad, open the file **Xitami.cfg**.
3. Scroll down the file to the section **[MIME]**. You will see that it is a list of settings for different text, image and application file types.
4. Scroll the end of the file and add the following new set of MIME type for files that are supported by H323 IP phones with a WAP browser.

```
# WAP MIME types
wml=text/vnd.wap.wml
```

5. Save the file.

4. Installing Sample WML Pages

Download the sample pages from Avaya (see the link above).

1. On the web server PC, open the folder **c:\Xitami\webpages**. For Apache and IIS use the appropriate root folder.
2. Create a new sub-folder called **4620**.
3. Copy the sample .wml pages into this folder.

4a. Creating a Simple WML Page

As an alternative to using the sample pages provided, you can create a simple .wml page using an editor such as Notepad.

1. Start Notepad.
2. Add the following text:

```
<?xml version="1.0"?>
<!DOCTYPE wml PUBLIC "-//WAPFORUM//DTD WML 1.1//EN"ξ "http://www.wapforum.org/DTD/wml\_1.2.xml"
<wml>
<card id="card1" title="Hello World!">
<p>Hello world!</p>
</card>
</wml>
```

3. Save the file as index.wml. Notepad may save the file as index.wml.txt. If this happens, rename the file back to index.wml.
4. Copy the file into the folder c:\Xitami\webpages\4620.

4b. Dialling from a WML Page

WTAI (Wireless Telephony Application Interface) allows numbers contained in a WML page to be dialed.

An example WTAI link is shown below:

```
<a href="wtai://wp/mc;200" title="Reception">Call Reception</a>
```

This example link displays as Call Reception and has an adjacent phone icon. Pressing the adjacent display key on the phone will dial the number contained in the link.

7.2 Setting the Home Page

WAP-capable H323 IP phones display a key option labeled **Web** when setup with a home page (press **PHONE/EXIT** if in any other menu).

To access the home page, press the adjacent display key. The home page is set by editing the **46XXsetting.scr** file found in the IP Office Manager applications program folder.

- For testing and demonstration purposes, Avaya hosts a set of WML files at <http://support.avaya.com/elmodocs/avayaip/4620/home.wml>.
- Most PC web browsers cannot display .wml files. However, Opera is able to display WML pages, which makes it a useful tool with which to test WML access and operation.

1. Locate the **46XXsettings.txt** file that has been previously downloaded to the phones. This will contain any custom settings for the Avaya IP phones being supported on the system.

- If only the file **46XXsettings.scr** is present, rename it to **46XXsettings.txt**.

2. Double-click on **46XXsettings.txt**. The file will open in Notepad. The section relating to WML browsing is towards the end of the file. It will look similar to the following:

```
##### SETTINGS FOR AVAYA 4620 IP PHONE #####
## 4620 Web Launch page in WML - Default: Avaya hosted
SET WMLHOME http://192.168.42.200/4620/index.wml
## The Proxy server used for your LAN - IP address or human readable name (check your browser settings).
# SET WMLPROXY nj.proxy.avaya.com
## The http proxy server port (check your browser settings).
SET WMLPORT 8000
## Exceptions: You must use an IP address not a DNS name
# Example: SET WMLEXCEPT 111.222.333.444
## Text coding for the web pages defaulted to ASCII.
SET WMLCODING ASCII
##### END OF AVAYA 4620 IP PHONE #####
```

3. Edit **SET WMLHOME** to be the address of the sample index.wml file on the web server. In this example; **http://192.168.42.200/4620/index.wml**.

4. If DNS is being used to access the web server by IP name, the **SET DOMAIN** and **SET DNSSVR** lines at the start of the **46XXsettings.scr** file should be edited to match the LAN settings. The preceding #s should be removed from the lines to make them active.

5. Close and save the file.

6. Restart the phones. Once the phone has restarted it should display **Web** as one of the screen option.

7.3 Apache Web Server WML Configuration

Apache is an open-source web server that is available on many platforms. Basic familiarity with Unix is necessary to configure it. The following is a step-by-step guide for configuring Apache Web Server:

1. To set MIME types in Apache, a plain text file called **httpd.conf** is used.
2. The location for this file varies depending on the individual setup, but the most usual path is **/etc/httpd/conf/httpd.conf**. If the operating system is Windows, then look for a folder called **conf** under where Apache is installed.
3. Using a text editor, open **httpd.conf**.
4. Scroll down to the **AddType** section (usually at the bottom of the file) and add the following line:

```
AddType text/vnd.wap.wml wml
```

5. Save the file.

7.4 Microsoft IIS Web Server WML Configuration

Microsoft Internet Information Server (IIS) is configured through the Internet Service Manager.

The following step-by-step guide can be used to set up MIME types necessary for WML:

1. Select **Start | Control Panel | Administrative Tools | Internet Services Manager**.
2. Right-click on **Server** and select **Properties**.
3. In the **Computer MIME Map** section, click **Edit**.
4. Click **New Type** and create a new file type using the parameters below:
 - **Associated extension:** wml
 - **Content type:** text/vnd.wap.wml
5. Click **OK**.
6. Stop and restart the web server so that the newly added MIME types are picked up.

7.5 Open URL Entry

This section provides sample WML coding on how to develop WML pages implementing a go-to URL function in the form of a text box. This code allows a user to enter a URL into a text entry area and link to that site.

Please note that these are examples, not an exhaustive list. All WML code is presented in italics.

Case 1. Input Box Followed by an Anchor Tag

Description: The user enters a URL into the text entry box and clicks on the URL to retrieve it.

```
<input name="url" title="Name" />
<anchor title="get it">
Go Get It
<go method="get" href="$(url)">
</go>
</anchor>
```

Case 2. Input Box Followed by an A Tag

```
<input name="url" title="Name" />
<a href="$(url)">Go Get It</a>
```

Case 3. Input Box Followed by a Submit Button

```
<input name="url" title="Name" />
<do type="submit" name="submit" label="Submit">
<go method="get" href="$(url)">
</go>
</do>
```

Case 4. Input Box Followed by an Anchor Tag Where the Anchor Tag Already Displays HTTP://

This method displays http so that the user only has to type in the URL at the end of http://.

```
<input name="url" title="Name" value="http://" />
<anchor title="GET">
Go Get it
<go method="get" href="$(url)">
</go>
</anchor>
```

Index

1

10Mbps 12
 1151C1/1151C2 48
 1152A1 48
 150ms 14

2

25ms 15
 264V AC 19

3

3.5W 19
 30A Switch Upgrade Base 19
 3rd-party
 HTTP 11
 TFTP 21

4

4600 7, 39, 55, 59, 84, 92
 4602SW 7, 18, 19
 4606 7, 18, 19
 includes 80
 4610SW 7, 18, 19, 55, 92
 4620 7, 19, 39, 80, 92, 93
 relating 95
 4620IP 18
 4620SW 7, 18, 55, 92
 4621SW 7, 55
 applies 19
 4622
 support 7
 4624D 19
 4624D01 19
 4624D02A 68
 4625SW 19, 55

5

5602SW 7, 18, 19
 5610SW 7, 18, 55, 92
 5620SW 7, 18
 5621SW 55

6

64ms 15

7

792ms 55

A

AC 19
 access point 7
 Active Directory using RADIUS 55
 address programming 49
 AddType 96
 administrative options 66, 68
 administrative tools 96
 Adtran Netvanta 3305 VPN Router 55
 Alternate DHCP Servers 11, 24
 Avaya IP 84
 Alternate Options 85
 Apache 96
 Appendix 76
 application file 68, 76, 77
 Application Notes
 Configuring 55
 Applications 14, 21, 55, 68, 71, 76, 77, 93, 95
 ASCII
 defaulted 95

ASDM 55
 Auto-create Extn Enable 24
 auto-negotiated 15
 Avaya 7, 14, 18, 19, 21, 22, 55, 59, 84, 95
 Avaya 1151C1 19
 Avaya 1151C2 19
 Avaya 1152A1 Power Distribution Unit 19
 Avaya 30A Switch Upgrade Base 18
 Avaya 4622SW IP Telephone 55
 Avaya Gateways 55
 Avaya H.323 IP 7
 Avaya P333T-PWR Switch 19
 Avaya SG Series 55
 Avaya Voice Priority Processor 7
 Avaya VSU Series 55
 Avaya WebLM 55
 Avaya VSU Series 55
 AVPP 7

B

Backup 17, 19
 Beam Address 81
 Beam Contact 81
 Beaming
 Files During 82
 bin/VPN Phone 55
 Button Programming 45

C

cabling 12
 Connections 17
 call answering 7
 Call Reception 93
 Call Server 59
 call signalling 15
 CallSv 49
 CAT3 12, 19
 CAT5 12, 17, 19
 Catalyst 19
 CD 21, 55, 93
 CD/DVD 55
 Cisco
 Configuring 55
 Cisco Adaptive Security Device Manager 55
 Cisco Catalyst 19
 Cisco PIX 500 Series Security Appliances 55
 Cisco PIX Security Appliance
 Configuring 55
 Cisco VPN 300 Series Concentrators 55
 CLI configuration 59
 cmd 55
 codecs 15
 Compact Flash 22
 Compaq iPAQ Pocket PC 81
 Computer MIME Map 96
 Concentrator 55
 configuring 55
 3rd-party 11
 Application Notes 55
 Cisco 55
 File Source 22
 VPNremote 55
 Connect 12, 15, 17, 18, 48, 55, 59
 Connections 12, 18, 19, 48, 55, 67, 68, 81
 Cabling 17
 Contacts 80, 81

Control Panel 96
Control Unit Memory Card
 Using 22
Control Unit Settings 24
Correct Boot File 77

D

Data 14, 15, 17, 18, 19, 48, 49, 59, 71
Default 15, 49, 55, 67, 71, 73, 77, 81, 93, 95
Deployment Guide 55
DHCP 11, 12, 14, 21, 49, 59, 66, 71, 73, 76, 85
 alternate 84
 connection 48
 introduction 7
 preparation 24
DHCP Address Installation 48, 49
DHCP addressing 73
DHCP Options 59, 73
DHCP Relay 59
DHCP Settings 59
DiffServ 17
DiffServ QoS 17
Direct Media 15
DNS 84, 85, 95
Documentation CD 93
Duplicate IP Addressing 17

E

Embedded Voicemail Memory 21
Endpoints 55
End-to-End Matching Standards 17
Enter TFTP 55
Ethernet 17, 59, 76, 81
 Power 19
Ethernet LAN 19
Ethernet Switch 59
Excessive Utilization 17
Extension ID 45
extensions 7, 12, 15, 24, 45, 51, 55, 80, 82, 95, 96
 phone requests 77
 user changes 77

F

File Source 22
File Writer 22
FileSv 49

G

G.711 15
G.722 15
G.729a 15
G.729b 15
Gatekeeper 11, 12, 24, 49, 73, 85
GEN 19

H

H.08.60 59
H.232 18
H.323 7, 18, 21
hostname 59
HP 59
HP Procurve 59
HP Procurve CLI 59
HP Procurve Ethernet 2626 PWR Ethernet 59
HP Procurve Switch 59

I

IEEE 802.2p/q 59
IEEE 802.3af 18, 19

IIS 96
IIS 5.0 96
IIS Admin Service 96
IKE Extended Authentication 55
index.wml 93, 95
Infrared Dialling 80
Initializing 48, 77
Input Box Followed 97
Internet 55, 96
Internet Information Server 96
Internet Service Manager 96
Introduction 7
IP Gateway 84
IP Mask 49, 59
IP Office Administration CD 24
IP Office Administrator 21, 55
IP Office Embedded Voicemail 21
IP Office IP Endpoint 7
IP Office Licensing 55
IP Office System 7, 11, 14, 15, 22, 55, 71, 81
IP Office TDM 15
IP Office Unit configuration 12
IP Office Unit Memory Card 21
IP Phone Inline Adaptor 19
IP Phone Software 7, 21, 24
IP Telephone 12, 55, 84, 92
IP400 55
IP403 7, 15
IP406 7, 15, 21, 22, 24
IP406 V1 7, 15
IP406 V2 7, 15, 21, 22, 24
IP412 7, 15
IPO 55, 59
IPO LIC 55
IPSets Firmware 21
IR 67, 80, 81, 82
IrDA 80
ISG 55

J

J8164A Configuration Editor 59
JRE 55
Juniper Networks
 Integrated Security Gateway 55
 NetScreen 55

K

Kentrox Q2300 VPN Router 55

L

L2 59
L2 QOS 59
L2Q 59
L2QVLAN 59
LAN 12, 17, 18, 19, 48, 55, 59, 67, 68, 76, 84, 92, 93, 95
LAN Cables 12, 18, 19, 48, 95
LAN Socket 12, 67
LED 19, 70
Licence Keys 12
Listing
 Registered 55
Loading 76, 77

M

M505 81, 82
MAC 55, 68
MAC Address 55, 68
Maintenance Manual 7

Manager application 11, 21, 24, 39, 49, 95
Manager Installation 7, 12
Manager PC 22, 24, 95
MCIPADD 59
MCPORT 59
MG 7
Microsoft 55, 85, 96
Microsoft DHCP 85
Microsoft IIS Web Server 96
Microsoft Internet Information Server 96
Mid-Span Power Unit 19
MIME 93, 96
Minimum Assessment Target 14
Minimum Firmware 55
MMC 96
Mode option 59
multicast 17
Multihomed 59
MultiVantage 84

N

Netgear FVS338 VPN Router 55
Network Access 17
network assessment 7, 14
NIC Cards 59
No Ethernet 48, 76
Non-Avaya 22, 55
non-IP 7, 15, 51
NT 4.0 96

O

Open URL Entry 97
Other H323 IP 7
Overlapping VLAN 59

P

Packet Loss 14
page coding 92
Palm 81, 82
Password 51, 77, 93, 95
PC Ethernet LAN 18
PC Port 18
PC Softphone 7
PC/Handheld
 lr 81
PC/personal 80
Phone Connection 48
phone displays 51, 77, 95
Phone Manager 7
Phone Security 45
PHY2 67, 81
Pocket PC 81
PoE 19
Potential VoIP Problems 17
power 12, 17, 18, 48, 51, 76
 Ethernet 19
 IP 19
power conditioning 17
power supply
 PSU 12, 17, 19, 48
Pre-Deployment 55
Preferences 24
preinstalled 24
preparation 24, 77
Preshared Key 55
Press Web 95
Print 55, 68

Printed Wiring Board 68
Program 12, 21, 49, 93, 95
Protection 17
Proxy 95
PSK 55
PWB comcode 68

Q

QoS 17
Quality 7, 14, 17

R

RAM 76, 77
RAS 55
Reboot 22, 45, 73, 77, 95
Registered 55
 Listing 55
registration 51, 77
Reset System Values 71
Resetting 71
Restarting 76
RFA Name 55
RFC2474 17
RJ45 12
 matching 19
 provides 19

S

Sample 95, 97
 Installing 93
SAP Code 55
Save 49, 55, 67, 73, 77, 93, 95, 96
Scope 59, 84, 85
script file 66, 76, 77
Secondary Ethernet 67
Self Installer 55
Self-Test Procedure 70
Serial Number 68
Setup 45, 59, 71, 76, 81, 95, 96
SG 55
Site Specific Settings 39
Small Installation 11
Small Office Edition 7, 12, 15, 17, 21, 22, 24
SMBLIC 55
Spare Wire 19
Speaker/Mute LED 70
SSON 73
Start Manager 95
static address 7, 21, 24, 48, 49, 66, 68, 76
Static Administration Options 66
Static IP 7, 12, 24
subnet mask 49, 84
support.avaya.com 55
SV 7
SW 18
Sysmon 55
System Overview 59

T

Tag 59, 92, 97
TFTP 21
Timed Out 76
timeout 21
toolkit 93
Tools 21, 39, 55, 81, 96
ToS 17

U

Unix 96
Unrestricted 59
Untagged 59
URL 97

V

VCard 81, 82
VCF 81
VCM 15, 24
 installing 15
 number 7
VCOMP 24
VLAN 49, 59
Voice 7, 12, 14, 15, 17, 18, 24, 59
Voice Compression Module 12, 24
voicemail 17, 22, 45
VoIP 7, 12, 14, 17, 45, 51, 55
VPN 55
VPNremote 55
VSU 55

W

WAN 17
WAP 92, 95
 Web Server 93
Watts 19
Web 39, 55, 59, 93, 95, 96
WebLM 55
Windows 22, 55, 80, 84, 85, 95, 96
 Windows 2000/Server 96
 Windows Notepad 39
 Windows NT 93
 Windows PC 93
 Windows Pocket PC 81
 Windows XP 96
Wireless Access Protocol 92
Wireless Markup Language 92
Wireless Telephony Application Interface 92, 93
WML 39, 92, 93, 95, 96, 97
Wordpad 55, 93
WTAI 92, 93

X

Xauth 55
Xitami 93
xml 93

Performance figures and data quoted in this document are typical, and must be specifically confirmed in writing by Avaya before they become applicable to any particular order or contract. The company reserves the right to make alterations or amendments to the detailed specifications at its discretion. The publication of information in this document does not imply freedom from patent or other protective rights of Avaya or others.

All trademarks identified by the ® or ™ are registered trademarks or trademarks, respectively, of Avaya Inc. All other trademarks are the property of their respective owners.

This document contains proprietary information of Avaya and is not to be disclosed or used except in accordance with applicable agreements.

© 2012 Avaya Inc. All rights reserved.